



MADE IN ITALY



S
N
O
N

GENERAL CATALOGUE

 ENGLISH

HISTORY



Dr. Prof. Celestino Ficai



Eng. Paolo Ficai on FICAI-IAP 750 - Bolzano-Mendola 1954.



Dr. Eng. Paolo Ficai

From I.A.P. (INDUSTRIA AUTOMOBILISTICA PARMENSE) manufacturer of racing cars, to **I.A.P. (INDUSTRIA ABRASIVI PARMENSE)**

Industria Abrasivi Parmense, subsequently evolved with the commercial brand GLOBE, originates in 1961 from an idea of Paolo and Pietro Ficai brothers, who availed of father Celestino's experience, full professor of Applied Chemistry at the University of Bologna, as well as co-founder and director of the Ceramic Centre linked to the Faculty.

Prof. Celestino's researches mainly focused on industrial ceramics, which at that time was growing in Modena area, on special cements, on the sintering of aluminum oxides to produce abrasive and refractory elements.

The idea of manufacturing abrasive wheels found its completion and realization in the factory in La Spezia street, Parma.

From 1961 to 1971, production was manual and manufactured with rotary distribution presses. Polymerization was already made through continuous ovens, really original (the first ones in the world), designed by engineer Paolo Ficai. In 1971, Eng. Giovanni Ficai joined the company,



The first headquarter of Industria Abrasivi Parmense in via La Spezia, 75

moving production to the new factory in 160, La Spezia street, where it widened over time until reaching the actual dimensions of approximately 6500 square metres.

From 1972 on, Eng. Giovanni and Dr. Pietro focused on a continuous and dynamic expansion aiming at products' improvement and automating production. Later, Eng. Giovanni internally designed and built all automatic presses, the continuous tunnel ovens and the mixing systems. So it was that, together with the high innovation and quality of GLOBE wheels, a company automation was developed, featured by a strong design originality thanks to the deep knowledge of production problems, which still continues today.

In 2001, Eng. Paolo Ficai, son of Eng. Giovanni Ficai, joined the company supporting and consolidating its development. In 2013, GLOBE acquired a new factory of 6000 square metres in Rubbiano di Solignano (Parma) on the highway A15, where GLOBE organized production of flap discs, as well as packaging and logistic operations. Research and development tirelessly proceed in all production stages with the aim of achieving new, better and advanced products.



Dr. Eng. Giovanni Ficai



Dr. Eng. Paolo Ficai

INDEX



01 GLOBE NEWS AND SPECIAL PRODUCTS
04 THE COMPANY AND THE MISSION
06 GLOBAL QUALITY: the safety of GLOBE products
07 GLOBE certifications
08 quality, experience, technology and research
14 IDENTIFICATION: labels, marking and traceability of the wheel
18 PRODUCTION: the three GLOBE lines (Plus, Evolution, Dynamic)



COMPANY



TYPE 41



TYPE 1

19 **FLAT THIN AND "CERAMIC POWER" CUTTING WHEELS**
(FOR PORTABLE ANGLE GRINDERS AND AXIAL MACHINES)
20 "CERAMIC POWER" CUTTING
21 HP-ONE, TOP-ONE, ZAC, ZIP-HP, EVOLUTION, DYNAMIC



TYPE 41

23 **FLAT STANDARD CUTTING WHEELS**
(FOR PORTABLE ANGLE GRINDERS)



TYPE 42



TYPE 1

24 **DEPRESSED CENTER THIN CUTTING WHEELS**
(FOR PORTABLE ANGLE GRINDERS AND AXIAL MACHINES)



TYPE 42

27 **DEPRESSED CENTER STANDARD CUTTING WHEELS**
(FOR PORTABLE ANGLE GRINDERS)



TYPE 41



TYPE 41



TYPE 42

31 **CUTTING WHEELS $\varnothing > 230\text{mm}$**
32 FLAT STANDARD and **SECURCUT** (STATIONARY MACHINES)
34 FLAT - **ALLCUT** (COMBUSTION ENGINE)
35 FLAT FOR RAILWAYS - **RAILCUT** (COMBUSTION ENGINE)
36 FLAT - **CHOPCUT** (FOR LIGHT STATIONARY MACHINES)
37 FLAT FOR CUTTING TEST PIECES - **LABCUT** (LABORATORY MACHINES)
38 DEPRESSED CENTER (SWING-FRAME OR STATIONARY MACHINES)



CUTTING



TYPE 27

40

COMBI "CERAMIC POWER"

(FOR PORTABLE ANGLE GRINDERS)

"CERAMIC POWER": DEPRESSED CENTER SPECIAL WHEELS FOR CUTTING/GRINDING



TYPE 27

41

COMBI EXTRA AND COMBI STANDARD

(FOR PORTABLE ANGLE GRINDERS)

SPECIAL AND STANDARD DEPRESSED CENTER WHEELS FOR CUTTING/GRINDING AND CAULKING

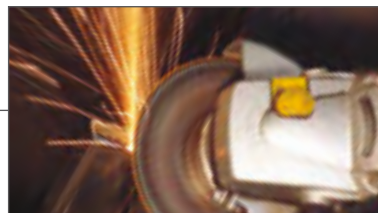

TYPE 27

42

COMBI SPEED

(FOR PORTABLE ANGLE GRINDERS)

SPECIAL DEPRESSED CENTER WHEELS FOR THIN CUTTING AND LIGHT GRINDING



TYPE 27

44

DEPRESSED CENTER GRINDING WHEELS

(FOR PORTABLE ANGLE GRINDERS)

SPECIAL GRINDING: CERAMIC POWER AND VIBLOCK

46

HEAVY GRINDING: GRIND POWER

47

STANDARD GRINDING



TYPE 1

49

GRINDING FLAT WHEELS

(FOR PORTABLE STRAIGHT GRINDERS)



50

FLEXCELLENCE & FLEXCELLENCE EXTRA - BEYOND THE FIBERDISC

(FOR PORTABLE ANGLE GRINDERS)

SEMIFLEXIBLE DEPRESSED CENTER DISCS FOR FLAT GRINDING



TYPE 29 (SEMIFLEXIBLE DISC)

52

TURBOTWISTER & TURBOTWISTER "CERAMIC POWER"

(FOR PORTABLE ANGLE GRINDERS)

TURBOTWISTER AND TURBOTWISTER CERAMIC POWER DEPRESSED CENTER GRINDING DISCS FOR FLAT GRINDING



TYPE 28

54

CONE - SAUCER GRINDING WHEEL

(FOR PORTABLE ANGLE GRINDERS)

DEPRESSED CENTER WHEEL FOR FLAT GRINDING



55

WHEEL FOR STRAIGHT AND BENCH GRINDERS

(FOR PORTABLE ANGLE GRINDERS)

CERAMIC BONDED SHAFT-MOUNTED WHEELS

56

BENCH WHEELS





59 **FLAP DISCS WITH FIBERGLASS SUPPORT**
(FOR PORTABLE ANGLE GRINDERS)



61 **FLAP DISCS WITH PLASTIC SUPPORT**
(FOR PORTABLE ANGLE GRINDERS)

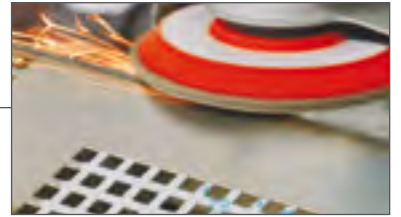

FLEXIBLE ABRASIVES

66 ABRASIVE CLOTH (BELTS, SHEETS, MINI ROLLS AND ROLLS)
68 ABRASIVE PAPER (ROLLS AND SHEETS)
69 SHAFT-MOUNTED FLAP DISCS
70 ABRASIVE FLAP WHEELS
71 SANDING DISCS



73 **FLEXIBLE ABRASIVES FOR FINISHING AND POLISHING**



74 NON WOVEN+CANVAS FLAP DISCS: **FINISHING PRO**



75 SHAFT-MOUNTED FLAP WHEELS:
NON WOVEN+CANVAS, NON WOVEN
76 ROLLS: CANVAS, NON WOVEN+CANVAS, NON WOVEN



77 NON WOVEN PADS AND ROLLS



78 NON WOVEN DISCS: **SCRUBBER**
79 NON WOVEN DISCS: **SHINING**



80 NON WOVEN AND FELT FLAP DISCS WITH ABRASIVE PASTE
81 ABRASIVE BARS AND SPONGES

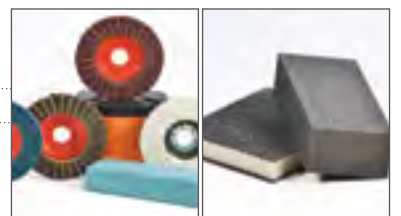

DIAMOND TOOLS

- 84 SEGMENTED AND CONTINUOUS RIM DISCS
- 85 CORERS AND TOOLS



- 87 **MINI DISCS FULL KIT FOR COMPRESSED AIR MACHINES**
COMPLETE RANGE OF PRECISION DISCS FOR CUTTING, GRINDING AND FINISHING (Ø 50 TO 75mm)



- 89 **STEEL & BRASS BRUSHES**
WHITE HAND-CLEANING PASTE (WITHOUT MICROPLASTICS)



- 90 **TUNGSTEN CARBIDE ROTARY BURRS**
(FOR PORTABLE STRAIGHT GRINDERS OR DRILL)



- 98 **BIO CLEANERS FOR METALS**
UNIVERSAL CLEANER: **CLEANER**
CLEANERS: **HV CLEANER, INOX CLEANER**
POLISHING AND STEEL PROTECTION: **SHINOX**



- 99 **WELDING PRODUCTS**
ANTI-SPATTER GEL: **WELD DYN**
ANTI-SPATTER SPRAY: **WELD EVO**
ANTI-SPATTER AEROSOL: **WELD PLUS**



- 100 **ACCESSORIES**
BACKING PADS WITH CLAMPING FLANGE FOR FIBER DISCS
PLASTIC SPACERS FOR ABRASIVE DISCS
STEEL FLANGES AND DAMPING FLANGES FOR DISCS
STEEL SPACERS (3 THICKNESSES AVAILABLE)
ADAPTOR RINGS FOR BIG DIAMETER CUTTING DISCS



- 101 **PROFESSIONAL GLOVES AND WELDER APRON**



- 102 **PACKAGING AND DISPLAYS**
COUNTER DISPLAYS (STEADY AND ROTATING)
FLOOR DISPLAY
PATENTED PACKAGING



SINCE 1961, WE DESIGN AND MANUFACTURE INNOVATING AND HIGH QUALITY PRODUCTS FOR YOUR WORK

NEWS

NEWS & SPECIAL PRODUCTS



Since 1961 **I.A.P. GLOBE** develops and manufactures abrasive tools of great value in terms of innovation and quality achieved with equipment internally designed and availing of proprietary and patented technologies.



TYPE 41

PLUS LINE
CUTTING TAGLIO

Max 13.300 rpm
80m/s

ISO 9001

STAINLESS STEEL
INOX & ACCIAIO

SG 60 SXBF
115x1,5x22,23 mm - TYPE 41
ART. G1663

PLUS    **CUTTING**

pag. 20

CERAMIC POWER (CUTTING)

The new GLOBE special cutting disc with ceramic grains specifically designed to perform numerous cuts ultra fast. (PATENTED).

TYPE 41



PLUS LINE
CUTTING TAGLIO

Max 13.300 rpm
80m/s

ISO 9001

STAINLESS STEEL
INOX & ACCIAIO

A 60 SXBF
115x1,0x22,23 mm - TYPE 41
ART. G1624

PLUS    **CUTTING**

pag. 21

TOP ONE

The highest stage ever achieved by a cutting disc. TOP ONE is made with the most performing abrasives and the most advanced technologies for unmatched durability. (PATENTED).

TYPE 41 **TYPE 42**

PLUS LINE
CUTTING TAGLIO

Max 13.300 rpm
80m/s

ISO 9001

STAINLESS STEEL
INOX & ACCIAIO

BATTERY TOOL OPTIMIZED

PLUS    **CUTTING**

pag. 21
pag. 25

HP-ONE

Better precision, speed, life and quality: all in 'one'.

XCELLENCE-ONE

The best GLOBE precision and safety in a disc with unique features, now also optimized for battery-powered grinders. (PATENTED).





TITANIUM

A special thin cutting disc, precise and high-performing, tailored for titanium processing. (PATENTED).

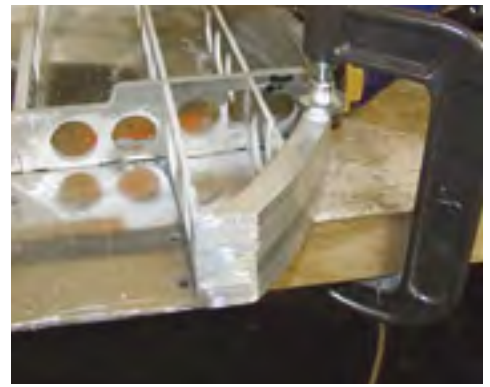

pag. 22



RAILCUT II LONG LIFE

Discs for rails with very long durability.

RAILCUT II FASTCUT

Disc for the fast cutting of rails.



pag. 35



CERAMIC POWER (COMBI)

The great cutting and grinding capacity of ceramic grains in a "unique" disc.



pag. 40



CERAMIC POWER (GRINDING)

Doubled removal capacity and higher speed thanks to the special ceramic grain mixture and the new formula. (PATENTED).



pag. 44



VIBLOCK

Special flange for TYPE 27 GLOBE discs.

Improves operator comfort as well as disc life and consumption by increasing the disc's removal capacity. (PATENTED).



pag. 45



PLUS GRINDING

pag. 50

FLEXCELLENCE e FLEXCELLENCE EXTRA

Special semi-flexible fibre discs (Flexcellence Extra with triangular ceramic grain) without backing pad. Operations under control working with great precision maximum comfort and very high efficiency.



TYPE 29



PLUS GRINDING

pag. 52

TURBOTWISTER CERAMIC-POWER

The semi-flexible disc, precise, fast and absolutely comfortable in use, is still more performing thanks to the special mixture with special ceramic grains.



GRINDING AND FINISHING

pag. 90

TUNGSTEN CARBIDE ROTARY BURRS

Tool line for roughing and finishing of hard metals, aluminium and other types of materials.



WELDING

pag. 99

WELDING PRODUCTS

Innovating anti-spatter and environmental friendly products for welding.



PROTECTION

pag. 101

GLOVES AND APRONS

Specialized products of hand and body protection for different types of jobs, welding, TIG welding...



MADE IN ITALY INNOVATING AND QUALITY PRODUCTS



The production plant in Parma.

As of today, GLOBE boasts fully automatic and absolutely precise mixing systems, 3 tunnel ovens for a cooking capacity of over 40 million pieces/year, an automatic press fleet able to produce any type of resin bonded discs with diameters from 30 up to 800 mm, in addition to an internal laboratory for testing raw materials, and a testing section for checking safety parameters and product performances. Research and development go on, tirelessly towards a continuous improvement of quality in order to reach an enhanced productivity and automation.

*The continuous research takes GLOBE to develop an important package of international patents, which characterize a wide range of products: **Combi Extra, Safecut III, ZAC, Grind Power III, HT flap discs (High Thickness), XCellence-One, special packaging, etc.***

Moreover, GLOBE distinguishes itself for the development of discs for special applications and materials such as cutting of test pieces, discs for robot-supported installations, rail cut, oil sector, processing of aluminium, titanium and other special alloys.

Thanks to a know-how handed down from 1961 and to a wide production flexibility, GLOBE is able to supply in a short time (and with the highest quality) products expressly designed for customers' needs and for different applications.

OUR AIMS

- High products performances
- Excellent quality/price ratio
- Maximum safety
- Excellent product reliability
- Continuous innovation
- User-friendliness and comfort
- Efficient sales service
- After-sales service
- Environmental protection

HOW WE OBTAIN THEM

- Selected raw materials, know-how, research and innovating manufacturing technologies
- Continuous controls during all production phases
- Internal production of plants and machines
- More than 55 years of experience in this field
- 4 generations of engineers and chemists
- Portfolio of international patents
- Constant engagement in research and development
- Innovating manufacturing machines and technologies
- Efficiency and quick deliveries



The logistic/production plant in Rubbiano.

MISSION



TO STAND OUT:

design, produce, deliver unique and high quality abrasive products through a constant research and the internal design/production of manufacturing machines.



TRADITION:

continue with passion and a constant devotion, the family business through the realization of the entire productive cycle "Made in Italy".



SAFETY AND QUALITY GUARANTEE:

supply safe and high-performance products in every way through certifications, severe internal and external controls on raw materials, process and final product; complete traceability of products as well as usage information, safety data sheets, after-sales service...



GLOBAL VISION:

pursue a global vision through the diffusion in all continents, always paying attention and adapting to special requirements of different markets.



SERVICE:

offer professional products, which can improve usage comfort and productivity, contributing to competitiveness, safety and to our partners' satisfaction, reducing their production costs. To support customers through the development of new, reliable, innovating and quality solutions. Fast deliveries and efficient after-sales service.



SPECIALIZATION:

through products expressly studied for every field: mechanical, oil, railways, chemical, building industry, naval, aerospace, etc.



INNOVATION:

devote to continuous research and development aimed at improving products.



VALUES:

add and to spread the value in all that we do. Value given by people, research and quality production.



SUSTAINABILITY AND ENVIRONMENTAL PROTECTION:

contribute to sustainability, both of process and of product, through certified production standards and the development of solutions with a small discard and more respectful of the environment, preserving it for future generations. Energy monitoring to minimize and optimize energy use. Analysis and control of emissions through processes and technologies, which guarantee an impact as limited as possible.



All GLOBE products are continuously tested and homologated according to international safety standards. Our laboratory daily carries out crash tests (pic. 1-2-3-4) and side load tests (pic. 5). All products are visually checked one by one before packing them, in order to guarantee safety, quality and reliability to customers and users. GLOBE wheels are produced in full compliance with safety requirements, and they are subject to strict tests in order to guarantee a safe use also in difficult situations. Layers of abrasive mixture are alternated with fiberglass reinforcements (certified European production) soaked with resins. The strong adhesion between reinforcements and binder of the mixture gives suitable features of endurance to the wheel. Safety has always been a priority for GLOBE: during production, check and use of products, and putting into every box complete and detailed instructions about storage and use (pic. 6), to support customers to work in full safety. Similarly, a wide area of the website www.globeabrasives.com is dedicated only to safety, to give additional information, safety data sheets, possible batches recalled, contacts to receive any type of information and links to associations, international organizations about the different aspects of safety.

GLOBE is a member of **FEPA** and **OSA**, the associations grouping the best manufacturers of abrasives in the world. **FEPA** and **OSA** members produce high quality abrasives of any type: rigid, flexible, non woven, super abrasive... for every field and business (automotive, aerospace, building industry, etc.), in compliance with strict regulatory safety protocols. Safety also means to adopt some simple rules by the user; we remind especially:

- to use discs wearing the prescribed personal protective equipments (gloves, goggles, noise-canceling headphones, etc.);
- to use appropriate machines and equipped with safety guard;
- to read and to adopt all safety measures listed in the safety instructions.



(Pic. 6) GLOBE instructions and safety data sheets in the packaging. They are at the end of this catalogue.

(Pic. 1-4) Machines for tests:



for discs with Ø from 50 to 230 mm



for discs with Ø from 115 to 350 mm



for discs with Ø from 300 to 500 mm



for discs with Ø from 600 to 800 mm

(Pic. 5) Machine for side load test and impact test.



GLOBE CERTIFICATIONS



GLOBAL QUALITY



GLOBE is one of the world manufacturers of top quality abrasive wheels, produced with raw materials supplied by ISO certified manufacturers in the European Union. All productions are carried out in the plants of Parma and Rubbiano (PR) - Italy.

Great care is always dedicated to chemical and mechanical safety of products for safeguarding and protecting users.

A prerogative of GLOBE products is the involvement and the responsibility of workers, obtained through a traceability system, which allows to trace at anytime and throughout the period of validity of every wheel: day, month, year of production, and all the staff involved in the manufacturing phases; from pressing to checking and shipping. Every phase of the production process is checked and stored: incoming raw materials, mixtures during production, pressing, registration of polymerisation cycles tests, and inspection before packaging.

In particular, tests of production batches and visual checks are carried out daily with certified machines and everything is stored in order to guarantee a very high safety level.

All documents are stored to guarantee a total traceability of every wheel produced. This careful management allowed us to obtain the ISO 9001 certification for many years already.

Moreover, since the early 2000s, GLOBE was admitted among the first producers in the OSA association (Organization for the Safety of Abrasives). Through strict and binding regulations, OSA guarantees a high standard of product safety for the protection of users.

Furthermore, GLOBE complies with the Italian regulations (DDL 320 dd. 5th November 1990, DDL 554 dd. 3rd December 1992) and the European ones (EN 12413 and EN 13743). It is also possible to produce certified abrasive discs and wheels for applications in nuclear plants in accordance with the different requirements of the different countries.



OSA certification



ISO 9001 certification

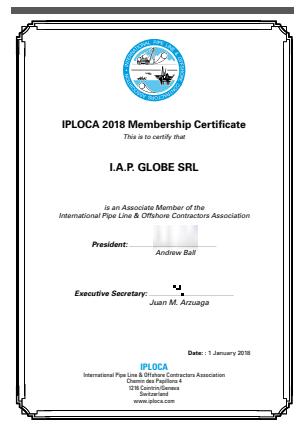

IPLCA certification



Nuclear certification

WORKING WITH ABRASIVE DISCS: QUALITY, KNOWLEDGE, TECHNIQUE AND RESEARCH ARE THE BASIS OF GLOBE PRODUCTIONS



XCellence-ONE:
ultra-thin cutting disc with very long durability. The depressed center "narrow dome" allows a bigger cutting penetration and a high number of cuts.



Flexcellence:
self-supporting fiberdisc. High removal capacity and long durability. Offers a big comfort of use and an excellent working precision.

Nowadays, abrasive wheels are the fastest and the most versatile tool that technology can offer for cutting and processing various materials. With abrasive cutting discs, you can cut metal profiles, any type of sheets, railway sleepers, reinforced concrete joists, stones, marbles, granites, refractory materials, pipes, melting of various alloys, foundry feeder-heads, steel test pieces, etc...

Continuous researches and improvements brought to widen the range of discs more and more selectively to enhance their performances for different works to carry out and for different materials. An example is the development of thin cutting wheels (thickness between 1,0 mm and 1,6 mm) which, thanks to their high penetration speed and to the cooling power of some additives and fillers, allow to carry out cold cuts avoiding the hardening of materials for self-quenching (common phenomenon when using cutting discs thicker than 2,5/3,2 mm) as well as to reduce the formation of burrs on the section cut.

The development of new products and solutions are one of the most important aspects of GLOBE work.

Just to mention some of them:

- the patented boxing system of wheels, unique in the world (cylindrical plastic or plastic coated cardboard boxes), which preserves and protects in the best way the wheel from ageing factors and degradation;
- the several new products put on the market by GLOBE, tools able to provide innovating solutions and better performances such as for example:

- Ceramic Power
- Top-One
- XCellence-ONE
- Safecut III
- Heavy Cut

- Grind Power III
- Railcut (Long Life and Fast Cut)
- Combi Extra e Combi Speed
- Flexcellence
- Viblock

THE INGREDIENTS OF THE WHEEL

Abrasive wheels are made of 3 main elements (in addition to the label and to the metal washer):

1. **cutting active element:** abrasive grains;
2. **binding element:** resins, that polymere in special polymerization ovens, bind and hold together manufactured products;
3. **strengthening elements:** fiberglass reinforcements used to increase products' resistance and to reach high rotation speeds in full safety.

1 - ABRASIVES

GLOBE always uses abrasives produced by the best European manufacturers; they guarantee high performances and constancy of physical/chemical parameters. Abrasives are among the hardest materials in Mohs scale. Thanks to this feature, they are able to scratch softer materials like metals and stone. Lots of little grains collectively scrape off and generate the cutting and grinding effect at the microscopic level.

Among the main types of abrasives there are:

aluminum oxide or brown corundum (pic. 1):

it is the most common of abrasives and has a medium level of toughness and friability. It is a crystal of aluminum oxide containing a small percentage of iron oxide and titanium oxide, which improve the features of toughness.

Ceramic-coated brown corundum (pic. 2):

the feature of this abrasive is to have a "cover" on abrasive grains able to increase adhesion between grain and binding resin. Its hardness and friability are similar to those of brown corundum and thanks to special milling processes it is possible to give grains different shapes (more or less rounded, sharp etc..) that determine different cutting capabilities and discs' durability.

Alumina zirconia (pic. 3):

it is very tough and has the special feature of "bursting" at high temperatures, in order that grain is regenerated with new cutting "edges". This type of abrasive is produced by introducing zirconium oxides during arc melting. Alumina zirconia, if used correctly, is one of the most efficient and long-lasting type of abrasive on the market; it has a very high toughness and hardness besides a very high resistance to the most difficult stresses thanks to its ability to self-change its cutting edges.

Semi-friable corundum (pic. 4):

more friable than brown corundum and less tough. This determines better cutting capability but less resistance to mechanical stress (this means an easier and faster cut but with a quicker consumption). Also this type of abrasive can be ceramic-coated in order to increase adhesion between grain and binding resin.

White corundum (pic. 5):

even more friable than the semi-friable one, it is however a bit tougher. Its features are: high cutting capability and low resistance to mechanical stress. Suggested for use on very hard metals.

Silicon carbide (pic. 6):

silicon carbide is one of the most sharp abrasives, and it is the most suitable for working non-ferrous metals, stones, refractory marbles, etc... Its high friability and hardness make this abrasive rather fragile but regular in its consumption. Especially for the sharpness and fragility of its crystals, it can only be used for a few applications but its very high hardness make it irreplaceable in working hard materials such as stone.

Ceramic abrasive or Sol gel (pic. 7):

produced by sintering (no electrofusion), it is the most valuable and performing abrasive as well as the most expensive. It has a limited use in the field of abrasive wheels, because of its high cost; in any case, it offers excellent cutting and abrasion. It is mostly used with abrasive papers and canvas where it is possible "to stick" grains to canvas in a strong way, thus enhancing its cutting capability.

These are only some of the abrasives available on the market, but there are also others such as monocristalline, pink, ruby red, etc. The combinations of these abrasives, agglomerated in resin matrix, usually phenolic (but also modified), with different powders and with specific additives, give wheels their special working properties making them more or less suitable for different applications.

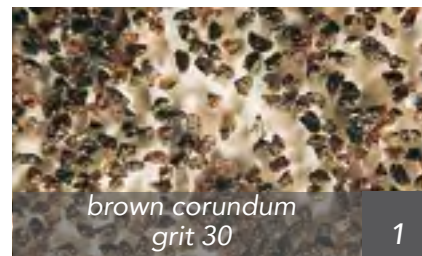

brown corundum
grit 30

1



ceramic-coated brown
corundum grit 36

2



alumina zirconia
grit 30

3



semi-friable corundum
grit 30

4



white corundum
grit 30

5



silicon carbide
grit 30

6



ceramic-coated abrasive
grit 30

7



PH metric titration of resin powder.



Titration of chemical compounds. Determination of viscosity.



Creep test for phenolic resin powder.



Yarn resistance test of fiberglass reinforcements.



Fiberglass reinforcements: some types of reinforcements of GLOBE wheels.

Granulometry of the abrasive chosen for the mixture is of great importance to characterize the wheel, it can be divided as follows and is expressed in Mesh:

coarse grits	12-14-16-18-20-22-24
medium grits	30-36-40-46-50-54-60
fine grits	70-80-90-100-120 and more

Granulometry has to be chosen according to the wheel's thickness (for example very coarse grits cannot be used in very thin wheels) and to the features (penetration capacity, hardness and lifetime) that the wheels should have.

Abrasive grains are also characterized by: shape, thermal treatment and "coating". In fact the grain can be rounded ("cube-shaped"), can have live edges, more or less long shapes, can be coated with ceramic material to improve adhesion with binding resin or can be baked again at high temperatures to obtain a higher toughness.

2 - BINDING RESINS

Resins used by GLOBE are produced only by European producers, selected over time for their reliability to supply high performance products and to keep the strict physical/chemical requirements necessary for manufacturing quality wheels.

Binding resin has the task to agglomerate abrasive grains and fiberglass reinforcements in a solid and strong body. The most used resins are phenolic in liquid and powder form. This type of resins has the important characteristic to give a high resistance to the heat developed during cutting or grinding. Phenolic resins are mixed with abrasives and additives in order to obtain a mixture, which is placed in the moulds of the hydraulic presses, and pressed at $200\div 300\text{kg/cm}^2$. The product obtained is placed between the metal cooking plates and then sent to polymerization ovens where there is the irreversible formation of chemical bonds between molecules of phenolic resin, allowing to obtain a solid matrix and resistant to stress and high temperatures.

3 - FIBERGLASS REINFORCEMENTS

Considering that abrasive wheels increase their performances with the increase of their peripheral speed, and considering that with organic resinoid binders only, it is impossible to obtain enough resistance to centrifugal forces (peripheral speed in the order of 80-100 m/s) and to different mechanical stresses, fiberglass reinforcements, soaked with resols and partially polymerized, become part of the wheel structure.

Thanks to these reinforcements, it is possible to obtain a structure properly reinforced, able to support high stresses and to reach the required safety values. Reinforcements are different: characterized by the weight/m² of canvas, by the type and weight of yarn (twisted or flat), by the mesh width, by the type and quantity of impregnation (a factor that guarantees adhesion to the mixture, composing the wheel).

Obviously, for higher peripheral speeds and stricter uses, heavier fiberglass reinforcements and in greater numbers will have to be used. Reinforcements can be applied on the sides and/or inside the disc, but for applications like laboratory discs for cutting test pieces, reinforcements are not used and considering that the wheel is fragile, safety is entrusted to the full enclosure of the machine.

HOW DISCS ARE MANUFACTURED

To build a high quality product, GLOBE carries out **continuous tests** on raw materials supported by sophisticated tools. Abrasive mixtures are produced automatically, and are computer controlled. Each abrasive mixture has its "identity card", which follows it for the entire lifetime of the mixture. This allows GLOBE, through its traceability system, to go back at any time to a specific mixture (type, day and hour of production) used for the production of every single wheel.

Each mixture is linked to registers of raw materials used for its production, allowing to consult all the relevant physical/chemical analysis previously done on the specific raw material.

The real building of wheels takes place by assembling single components (fiberglass reinforcements, abrasive mixture, metal washer and label) through modern automatic presses (built by GLOBE).

A typical wheel is structurally conceived with a layer of upper fine grit mixture, which better bears crashes and stress, keeping a regular wear of the edge and with additional layers of coarse mixture to enhance removal performances.

Cutting discs, having to be particularly thin, are almost always made by two external fiberglass reinforcements with only one layer of abrasive mixture in between. Usually, large diameter discs (and consequently thicker) are made of more layers of abrasive mixture (of the same type).

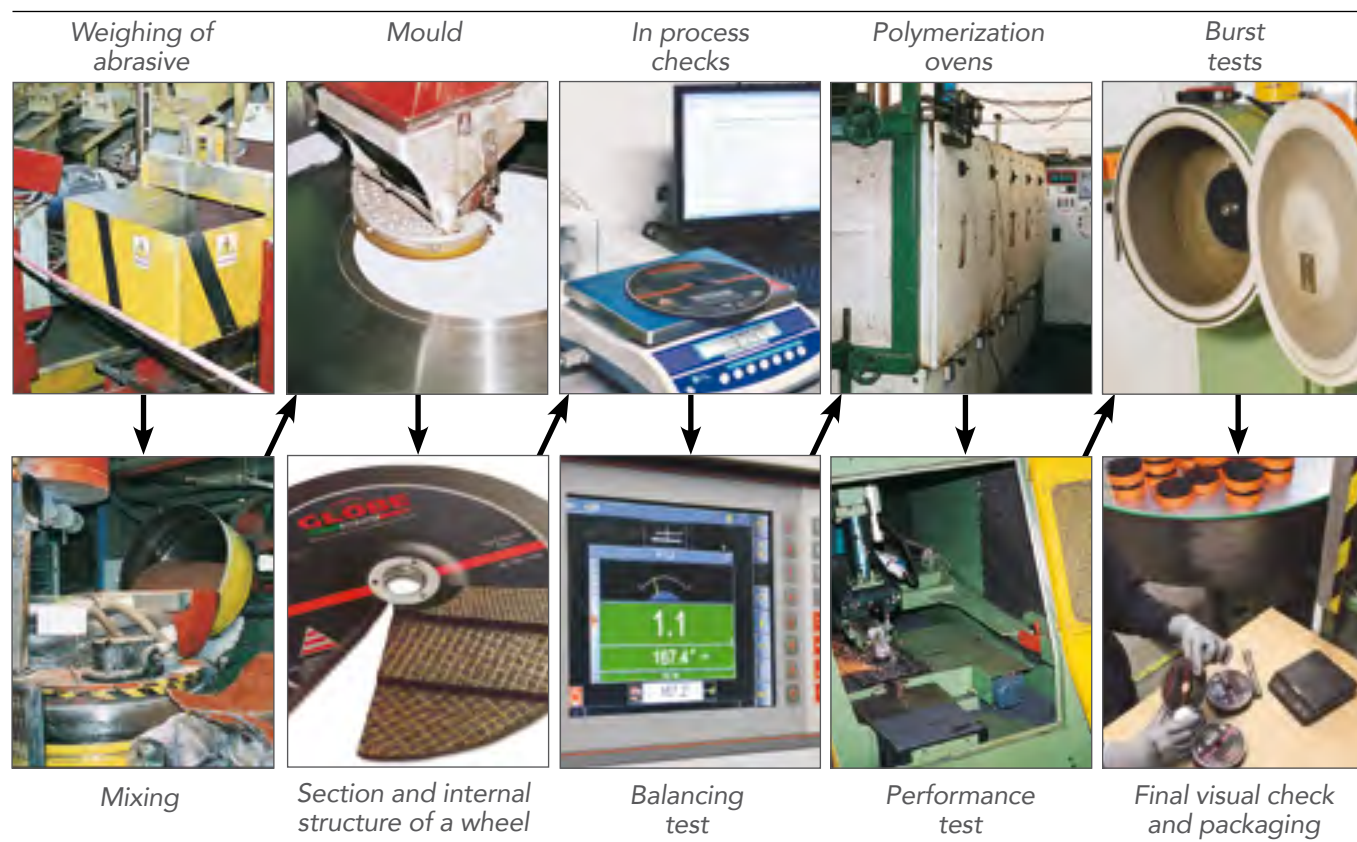

During the wheel moulding phase in the press, hundreds of checks are carried out every day, verifying especially, the main parameters of the wheel: weight, thickness, bore diameter, general appearance of the product and balancing. Balancing is carried out through modern electronic systems, and always keeping an unbalance level much lower than the one allowed by the present regulations UNI ISO 6103. The bore tolerance is constantly checked in accordance with ISO 525 regulations. In fact, too small bores prevent the correct installation, while, too big bores cause vibrations during use because of an eccentric mounting.

All production data are collected in electronic format, and they are stored for years for a perfect traceability. Wheels, so pressed, cannot be used yet because the mixture binding resin has to undergo a polymerization process, which gives the necessary and final mechanical resistance. To this aim, wheels are piled on special trolleys (between metal cooking plates, that protect their flatness). Trolleys full of wheels are sent to the polymerization tunnel (built by GLOBE).

Inside the tunnel, wheels follow a slow and progressive raising of temperature adjusted and monitored through sophisticated electronic tools, perfectly following the cooking cycles studied on purpose. The cooking processes are filed on a computer allowing to go back for each wheel (through the traceability system) to the specific temperature cycle followed. Once wheels are polymerized and cold, the prescribed sample checks are made to verify mechanical resistance, and data are entered into electronic archives. The final phase consists in a visual inspection of every single wheel to isolate possible faulty pieces, and ends with packaging. All the above mentioned procedures allow GLOBE to control and fully trace each wheel produced guaranteeing a high standard of quality, safety and reliability.

TECHNICAL NEWS ABOUT CUTTING DISCS

Besides components and types of raw materials used for production of abrasive wheels, the building technique is fundamental. For example to obtain a better performance and a higher structural density in cutting discs, rubber moulds are used in the pressing phase that stamp a high surface roughness on the cutting disc's sides under pressures in the order of 300 Kg/cm². This roughness is very important to obtain a fast penetration and a cold and white cut, especially when cutting full sections and it is stronger in discs without side reinforcements.

If cutting discs are reinforced inside, they usually have a rougher surface on the sides (in fact, in these cases, external reinforced with smaller diameter are often used), which allows a better penetration into the piece. If external reinforcements are on the whole diameter, a better resistance to side stresses is obtained, but more difficulty in penetration due to the friction of fiberglass reinforcements on the sides.

One of the possibilities to minimize this problem, is to use cutting discs with a suitable thickness for the work to be carried out. Important information on proper use and good operation of a cutting disc can be obtained by observing the edge shape which originates during cutting.

In fact:

if the edge section is flat or slightly concave in the center (A) it means that there was a correct operating performance, showing a right balance between cutting performance and disc consumption. The slight concavity that can arise in the middle is usually due to a central fiberglass reinforcement wearing out faster than the side areas;

if the edge section is pointy (B), and there are crumbled areas on the edge, dark colour and burning smell, it means that the disc is too hard and not suitable for the type of cut currently being carried out (usually not suitable for cutting full sections or for the type of material being cut). Going on with the work may lead to jamming or breaking of the disc;

if the edge section is pointy and asymmetric (C) one of the following situations is happening:

- 1) the piece to be cut or the moving forward (positioning) of the wheel are misaligned.
- 2) the wheel, manufactured with an abrasive mixture with different grit sizes, was wrongly subject to grit separation during distribution and pressing, so that fine grit sunk down and coarse grit remained on top. This determines a different density and hardness on the two sides of the disc and causes an uneven consumption of the disc.

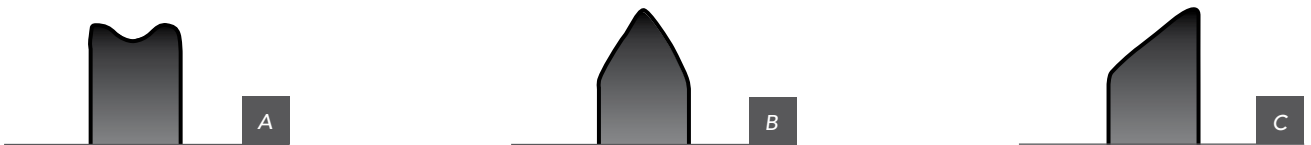

Caution: in both above mentioned cases it will lead to straining and to possible breaking of the wheel.

The choice of the most suitable cutting wheel to be used for the work to carry out is also strictly tied to the cutting mode with which the cut will be made (machine and shape of the pieces to be cut). The aim is to achieve a fast and white cut (in the shortest time possible) thus limiting the heat developed in the process.

Some examples of the most common working methods are:

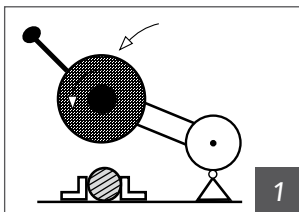

1) workpiece locked and cutting wheel going down vertically on the workpiece.

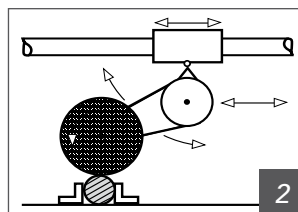

2) workpiece locked on the bench of a bridge machine with stationary or swinging cutting wheel horizontally; or stationary or swinging cutting wheel with horizontal moving of the piece on mobile trolley.

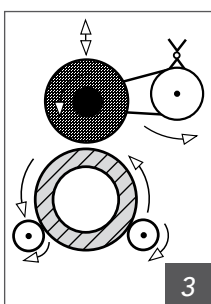

3) cutting wheel comes down vertically on the workpiece which is rotated by means of special mechanical equipment. The cutting wheel may also be swing-frame and swing from top to bottom.

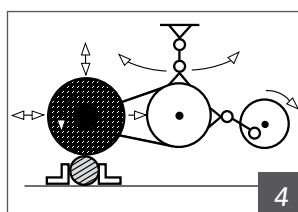

4) cutting wheel comes down vertically and swings horizontally (sometimes also vertically) on the workpiece locked on the bench.

UNBALANCE ACCEPTED, TOLERANCE OF BORES AND SPEED (RPM) OF GRINDING AND CUTTING DISCS

GLOBE pays special attention in balancing wheels with products respecting even stricter values than those foreseen by the UNI EN ISO6103 reference norms.

$$m_a = K \sqrt{m_i}$$

Where:
 m_i = wheel mass
 K = is obtained from the following table

USE	MACHINE	TYPE	DIMENSIONS		Coefficient K for maximum operating speed (m/s)		
			Diameter mm	Thickness mm	16 ≤ vs ≤ 40	40 < vs ≤ 63	63 < vs ≤ 100
GRINDING	PORTABLE	Type: 1/27/28/29	115 < D ≤ 150	-	0,40	0,32	0,25
			150 < D ≤ 180	-	0,40	0,32	0,20
			D > 180	T ≤ 6	0,40	0,32	0,20
				T > 6	0,32	0,25	0,20
CUTTING	PORTABLE	Type: 41/42	115 < D ≤ 400	-	0,40	0,32	0,20
	SWING FRAME OR STATIONARY	Type: 41/42	D < 300	-	0,50	0,40	0,32
			D > 300	-	0,63	0,50	0,40

vs: peripheral speed of disc during the use.

MAXIMUM UNBALANCE ADMITTED.

The maximum unbalance admitted (m_a) is governed by the norm UNI ISO 6103 and is expressed in grams on the disc's periphery.

d = bore diameter	until 18mm	[+0,15 / - 0] mm
	from 18 to 30mm	[+0,21 / - 0] mm
	from 30 to 50mm	[+0,25 / - 0] mm
	from 50 to 80mm	[+0,30 / - 0] mm

BORE TOLERANCE.
 UNI ISO 525 norm,
 for cutting and grinding wheels.

Wheel diameter in mm	PERIPHERAL SPEED			
	45 m/sec. RPM	63 m/sec. RPM	80 m/sec. RPM	100 m/sec. RPM
50	17200	24100	30600	38200
75	11455	15300	20400	25470
100	8600	12100	15300	19100
115	7500	10500	13300	16650
125	6900	9650	12250	15300
150	5750	8050	10200	12700
180	4800	6700	8500	10650
200	4300	6050	7650	9550
230	3750	5250	6650	8350
250	3450	4850	6150	7650
300	2870	4050	5100	6400
350	2450	3450	4400	5500
400	2150	3050	3850	4800
500	1750	2450	3100	3850
600	1450	2050	2550	3200
800	1075	1550	1950	2400

TABLE OF CORRESPONDENCE PERIPH. SPEED/RPM/ DIAM.



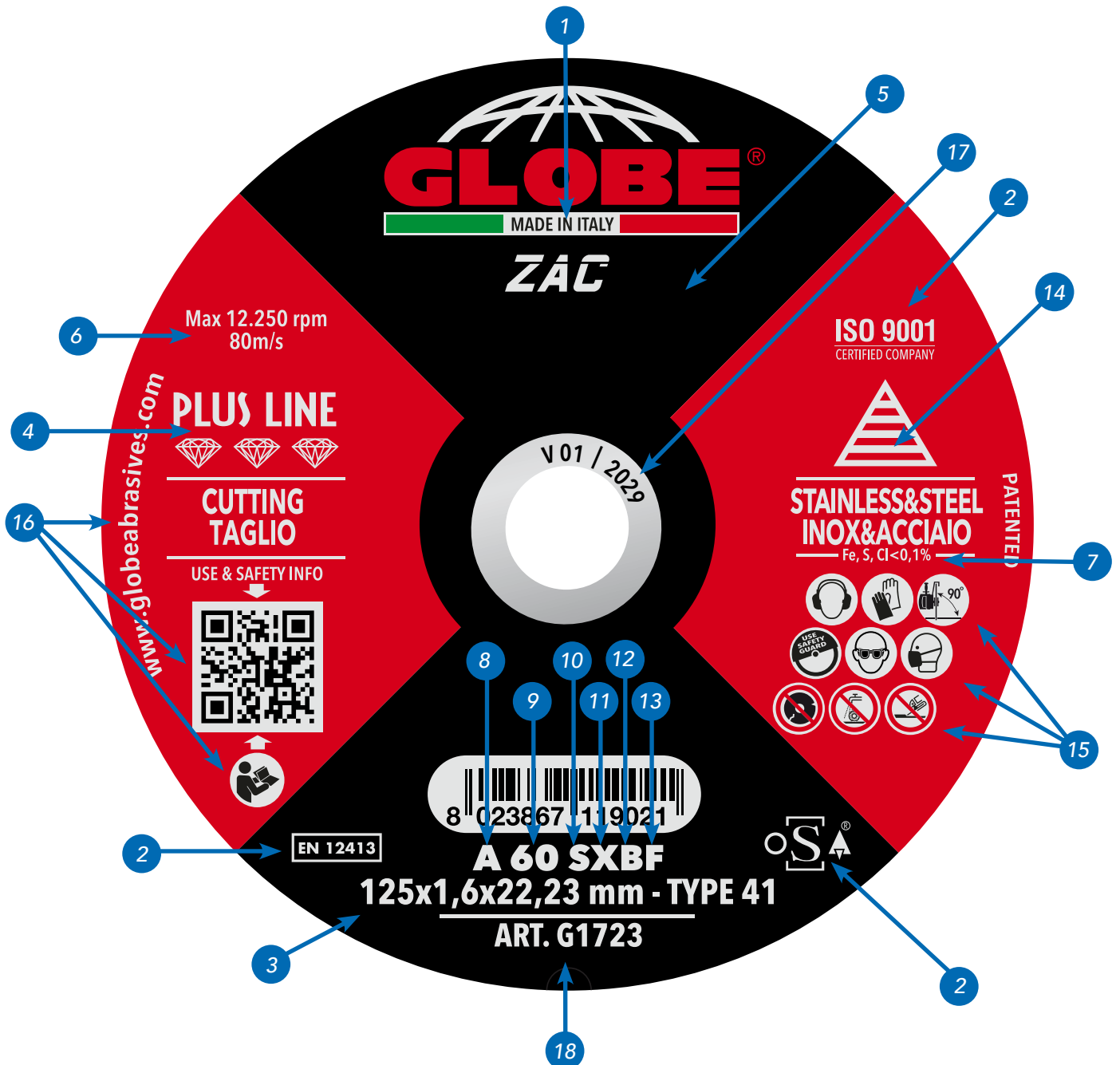



READING THE LABEL



- 1) MANUFACTURER:
IAP - GLOBE srl. Via La Spezia, 160 - 43126 Parma - Italy

- 2) CERTIFICATION OF THE COMPANY: ISO 9001;
CERTIFICATION OF PRODUCT: OSA (Organization for the Safety of Abrasives);
REGULATIONS REFERENCE OF THE PRODUCTS: EN 12413; EN 13743 (flap discs).

- 3) SIZE AND USE: outer diameter, thickness, bore diameter (in mm) and disc usage (TYPE).

- 4) THE 3 GLOBE LINES:    PLUS |   EVOLUTION |  DYNAMIC

- 5) PRODUCT NAME: when available

- 6) WHEELS/DISCS' OPERATING AND PERIPHERAL SPEED: in RPM and m/s

- 7) CONTENT SPECIFICATIONS: iron, sulphur, chlorine.

- 8) TYPE OF ABRASIVE:
A-Corundum (aluminum oxide) C-Silicon carbide
Z-Alumina zirconia SG-Sol gel (ceramic abrasive)

- 9) GRIT SIZE:
coarse: from 16 to 24 medium: from 30 to 60 fine: from 70 to 120

- 10) HARDNESS:
P/Q: medium R/S: hard T: very hard

- 11) DIRECTIONS FOR SPECIFIC APPLICATIONS:
Al: Aluminium X: Stainless steel
G: Cast iron E: Building materials

- 12) TYPE OF BINDER: B = phenolic resin

- 13) TYPE OF REINFORCEMENTS: F = fiberglass cloths (if absent = disc/wheel not reinforced)

- 14) COLOUR OF IDENTIFICATION OF THE TYPE OF USE:
the colour of triangles identifies the type of material where to use the wheel

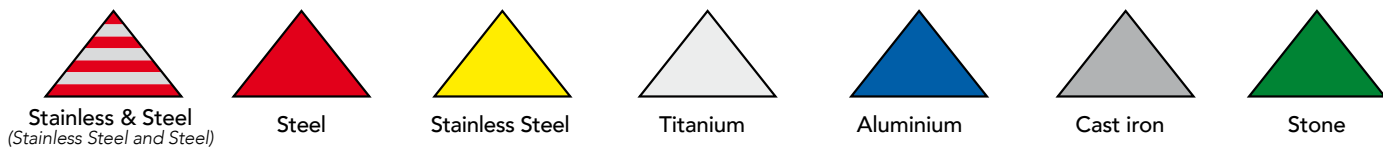

- 15) SAFETY PICTOGRAMS:
symbols of prohibitions and prescriptions on labels, website, package leaflets, etc, which must be observed by the worker. GLOBE products are professional tools, the use of which is intended for experienced staff.
-

16) INDICATION OF THE WEBSITE FOR INFORMATION ABOUT THE PRODUCT:
visit the SAFETY AREA of the website with all useful information to choose the product along with the instructions for a correct use.

17) EXPIRY DATE:
wheels for portable machines are valid for three years* starting from production date. Wheels for stationary machines do not expire. If necessary, the expiry date is available:
on the WHEEL, printed on the metal washer where the expiry date (V=validity) is written in quarter and year, if there is no washer, the expiry date is directly printed on the disc;
on the BOX, in the special adesive label on which also the following data appear: production date, operator in charge of the wheel's manufacturing, operator in charge of checks before packaging, packaging date.

*LABCUT discs have two years' validity.

18) ARTICLE CODE:
allows the identification of each GLOBE product.

TRACEABILITY SYSTEM

- 1** Operator in charge of closing the baking trolley
 - 2** Operator in charge of wheels' unpiling
 - 3** Operator in charge of wheels' check
 - 4** Operator in charge of packaging
- P** Wheels' production date
- PACK/D** Boxing date

GLOBE WWW.GLOBEABRASIVES.COM		Via La Spezia, 160 43126 PARMA - ITALY Tel: +39.0521.293943 Fax: +39.0521.293743
QTY	25	ART G0112
DESCR	CD 115X6,5X22mm A 24-30-36 QBF	
OPP 1: DEX 2: MEN 3: NIC 4: DAL P: 28.07.2024 PACK/D: 01.08.2024		
MOLE PER SBAVATURA A CENTRO DEPRESSO DEPRESSED CENTER GREENING WHEELS MEULES D'EBARBAGE		
 8 0 2 3 8 6 7 1 0 0 0 4 3		
		MADE IN ITALY
		VAL 28.01.2029
		



Checking product conformity.



The packaging of GLOBE products.



The stackable and reusable exclusive box (patented by GLOBE), protects and preserves products' performances over time.

For each single GLOBE wheel, at the moment of manufacturing, an individual label is prepared showing day, month and year of expiry (the same as those of manufacturing but with 3 years more) as well as identity of the operator in charge of pressing. Labels are prepared through a special machine connected to the central computer system.

Daily production of each press is indicated in a production sheet where checks of weight, balancing and thickness of wheels are recorded.

These sheets also include characteristics of the mixture used. Thanks to this information it is possible to quickly trace the batches of raw materials used, their chemical- physical checks are stored both in computer and printed files.

Production sheets trace batches through baking up to the final product test and boxing.

When polymerization is over, the product is transferred to warehouse, where each single wheel is checked and, if approved, is boxed and packed. The codes of the operators who made the checks are shown on the label of the box and of the packing. All checks carried out (with the signature of who made them), also after manufacturing, are reported on the sheets and are electronically stored for the whole product's lifetime (three years after manufacturing date).

On every batch, all resistance tests foreseen by the EN and OSA regulations are carried out.

All data are stored and available. In case of necessity, through the traceability system, it is possible to go back to these data for each single batch.

PROTECTION DURING STORAGE

GLOBE thin cutting discs are packaged in hard plastic plastic boxes (GLOBE patent) stackable and reusable.

These boxes protect and preserve the product keeping it at the top of the performance.

For diameters over 125mm the stackable and reusable cylindrical packs are available with cardboard cylinder and plastic caps.

PRODUCT INFO AND SAFETY AREA ALWAYS UPDATED AND AVAILABLE FOR YOU... WITH A CLICK



WEB

WWW.GLOBEABRASIVES.COM

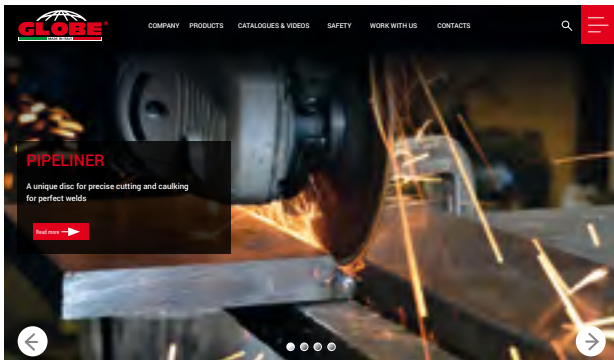

SINCE 1961...
We engineer and manufacture abrasive discs at the top for performance, quality and safety.

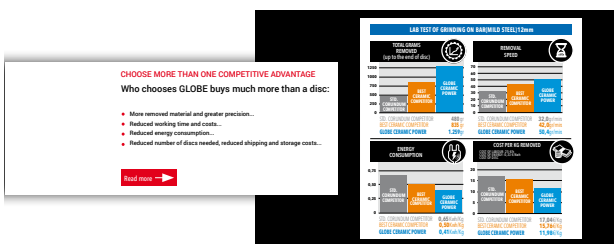
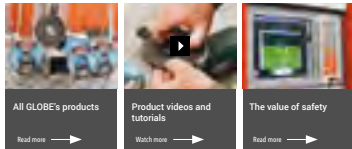

NEWS 2024
Our latest innovations at the service of your performance and profitability.

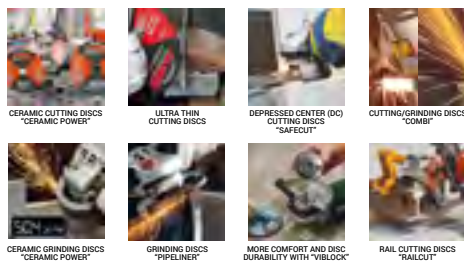

Considering the peculiarities of GLOBE products, the site is basically composed of two main thematic areas: one dedicated to products and the other one dedicated exclusively to safety in its multiple aspects, a very important topic for GLOBE.

PRODUCTS:

the general catalogue and the product brochures with the latest new products launched by GLOBE on the abrasives market;

contacts of the various production and sales departments (both for Italy and abroad);

company certifications and operating instructions of abrasive products...

SAFETY:

information about reading and coding of GLOBE products;

regulations and way of use of abrasive products;

possible batches recalled...

3 PRODUCT LINES FOR 3 DIFFERENT NEEDS



PLUS



EVOLUTION



DYNAMIC

- Very long durability
- Extreme speed for cutting and grinding
- Very high precision
- Reduced overheating
- Reduced burrs' formation

PLUS LINE: INCOMPARABLE PERFORMANCES

PLUS is the more complete and performing GLOBE line of cutting and grinding discs. It was studied to satisfy the most demanding professionals. Result of an experience gained in 60 years of research and development, the Plus line confirms the positioning of GLOBE among the best producers in the world market.

WHY CHOOSING THE PLUS LINE

Choosing the Plus line, means asking for the best under every point of view, and an absolute guarantee of profit through a longer product's durability, reduction of working time and better quality of the same. Available for: iron and steel, stainless steel, building industry, aluminium, alloys and titanium.

- Reduced working costs
- Long durability
- High cutting speed
- Very high precision
- Line completely exempted from: Fe, S, Cl

EVOLUTION LINE: A CONTINUOUS EVOLUTION

EVOLUTION is a new line of GLOBE cutting discs. These products are suggested both for steel and stainless steel and they are designed for operators, who need a good product with a good price. EVOLUTION is the perfect solution for resellers and end users.

WHY CHOOSING THE EVOLUTION LINE

The EVOLUTION line guarantees a perfect working of stainless steels without contamination and without sacrificing GLOBE quality.

- Good durability
- Good cutting and removal speed
- Good precision
- Economical and safe

DYNAMIC LINE: A GOOD PRODUCT AT A GOOD PRICE

Dynamic is the GLOBE line for large-scale distribution, with an excellent value for money. The Dynamic line is composed by a wide range of discs able to satisfy the different areas of application: cutting discs (thin, standard and big diameter cutting) and grinding wheels.

WHY CHOOSING THE DYNAMIC LINE

As for the other GLOBE discs, also the Dynamic ones respect the strict quality standards and the resistance tests, strictly observing the safety regulations. GLOBE experience guarantees customers an excellent "entry level" solution.



TYPE 41



TYPE 1

20 **FLAT THIN AND "CERAMIC POWER" CUTTING WHEELS**

(FOR PORTABLE ANGLE GRINDERS AND AXIAL MACHINES)

"CERAMIC POWER" CUTTING

HP-ONE, TOP-ONE, ZAC, ZIP-HP, EVOLUTION, DYNAMIC



TYPE 41

23 **FLAT STANDARD DISCS**

(FOR PORTABLE ANGLE GRINDERS)



TYPE 42



TYPE 1

24 **DEPRESSED CENTER THIN DISCS**

(FOR PORTABLE ANGLE GRINDERS AND AXIAL MACHINES)



TYPE 42

27 **DEPRESSED CENTER STANDARD DISCS**

(FOR PORTABLE ANGLE GRINDERS)



TYPE 41



TYPE 41



TYPE 42

CUTTING DISCS Ø>230mm

32 FLAT STANDARD and **SECURCUT** (STATIONARY MACHINES)

34 FLAT - **ALLCUT** (COMBUSTION ENGINE)

35 FLAT FOR RAILWAYS CUT - **RAILCUT** (COMBUSTION ENGINE)

36 FLAT - **CHOPCUT** (FOR LIGHT STATIONARY MACHINES)

37 FLAT FOR CUTTING TEST PIECES - **LABCUT**
(LABORATORY MACHINES)

38 DEPRESSED CENTER (SWING-FRAME OR STATIONARY MACHINES)



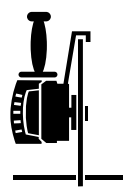

TYPE 41

FLAT CUTTING DISCS FOR PORTABLE ANGLE GRINDERS



GLOBE thin cutting discs are the most performing and fastest cutting tools on the market. The very thin thickness allows to halve cutting times of conventional discs. Available for the most varied uses and materials (iron, stainless steel, aluminium, titanium, alloys and stone).

MATERIAL	DIMENSIONS (diam - thick - bore) mm	HARDNESS	USE SPEED	ARTICLE CODE		PLUS LINE
----------	-------------------------------------	----------	-----------	--------------	--	-----------

STAINLESS STEEL AND STEEL

SG 60 SXBF CER: the new and special GLOBE CERAMIC POWER cutting disc has been specifically designed to perform many and ultra-fast cuts, maintaining an excellent and constant cutting quality and a minimum overheating of the metal (less burrs and less pitting). Ideal for all steels (including stainless steel) thanks to the new high-performance binder and the reinforced structure for heavy-duty works, it allows high productivity and at the same time a reduction of working costs.

DISC DURABILITY

CUTTING SPEED

CLEAN CUT

PATENTED
ALL THE ADVANTAGES OF GLOBE CERAMIC POWER (CUT)

NEW	NEW	NEW	NEW	NEW	NEW	NEW
115x1,0x22,23	CERAMIC	SG 60 SXBF CER	80 m/s	G1661 •	25pcs	
115x1,5x22,23	CERAMIC	SG 60 SXBF CER	80 m/s	G1663 •	25pcs	
125x1,0x22,23	CERAMIC	SG 60 SXBF CER	80 m/s	G1761 •	25pcs	
125x1,5x22,23	CERAMIC	SG 60 SXBF CER	80 m/s	G1763 •	25pcs	
150x1,6x22,23	CERAMIC	SG 60 SXBF CER	80 m/s	G1773 •	25pcs	
180x2,0x22,23	CERAMIC	SG 60 SXBF CER	80 m/s	G1783 •	25pcs	
230x2,0x22,23	CERAMIC	SG 60 SXBF CER	80 m/s	G1793 •	25pcs	

- NEW CERAMIC GRAIN
- COMFORT FOR THE USER
- EASE OF USE
- QUICK AND PRECISE CUT
- VERY HIGH PRODUCTIVITY
- REDUCED VIBRATIONS
- ULTRA FAST CUTS WITH LESS PITTING
- LESS ENERGY AND LESS LABOUR COSTS
- ULTRA FAST CUT
- LONG DURABILITY
- REDUCTION OF WORKING TIME
- REDUCTION OF ENERGY/LABOUR COST



Every ceramic grain (smaller and sharper than aluminum oxide grain) contains hundreds of thousands of microcrystals, which, during cutting operation, multiply life and efficiency of the disc by increasing its precision and cold cutting.

LAB CUTTING TEST ON FLAT PROFILE (MILD STEEL) 50x6mm AND 125x1,5mm DISCS

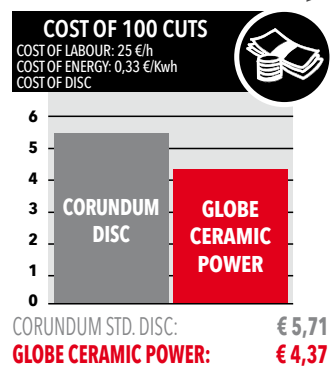
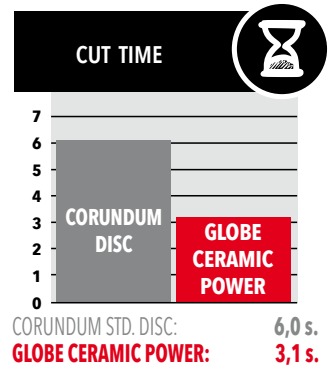
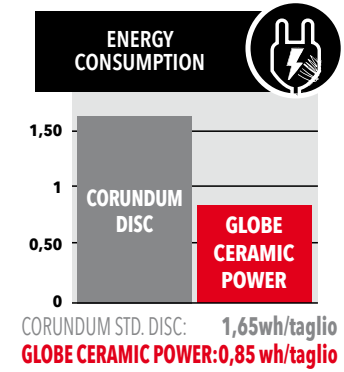
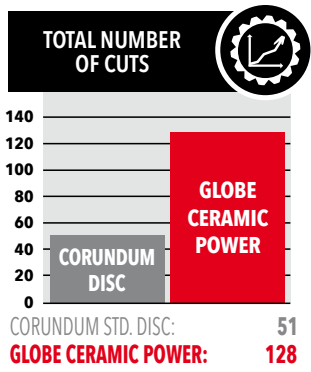

• = articles always in stock

MATERIAL	DIMENSIONS (diam - spess - foro) mm	HARDNESS	USE SPEED	ARTICLE CODE	
----------	--	----------	--------------	-----------------	---

PLUS LINE   

 **STAINLESS
STEEL AND
STEEL**

ZA 60 SX: HP-ONE discs (thickness 1,0 mm) offer unique performances thanks to the zirconia mixture. Very fast and ultra-precise cutting with maximum durability. Cold cut minimizes burrs and pitting on stainless steel.

NEW	115x1,0x22,23	HP ONE	ZA 60 SX	80 m/s	G1624 HP ONE •	25pcs
NEW	125x1,0x22,23	HP ONE	ZA 60 SX	80 m/s	G1721 HP ONE •	25pcs

HP-ONE is the new ultra-thin disc (**1,0 mm**) for precision cutting of tubes and thin sheet metals. Although it is very thin, this disc is very rigid and has a long durability, meeting all the safety requirements.

DISC DURABILITY 
CUTTING SPEED 
CLEAN CUT 





HP-ONE

 **STAINLESS
STEEL AND
STEEL**

A 60 SX: TOP-ONE is the state of the art disc, manufactured with the finest and highest performance abrasives and using advanced and innovative production technologies, TOP-ONE includes unique performances to the total advantage toward the work to be done and operator:

- **HIGH RIGIDITY CUTS**
- **HIGH PRECISION CUTS**
- **LOW VIBRATIONS**
- **NO BURRS**
- **COOL CUTS**
- **HIGHEST DURABILITY AND SPEED**
- **NO CONTAMINATION (Fe,S,Cl FREE)**
- **EXTRA SAFETY**

NEW	115x1,0x22,23	TOP-ONE	A 60 SX	80 m/s	G1624 •	25pcs
NEW	125x1,0x22,23	TOP-ONE	A 60 SX	80 m/s	G1721 •	25pcs

DISC DURABILITY 
CUTTING SPEED 
CLEAN CUT 

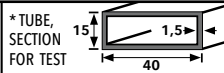

DIY 59	* TUBE SECTION FOR TEST	
COMPETITOR 81		
BEST COMPETITOR		131
GLOBE TOP-ONE		160
N° OF CUTS		

COMPARATIVE CUTTING TESTS ON STAINLESS STEEL* TUBE WITH 125mm CUTTING DISCS.

 **STAINLESS
STEEL AND
STEEL**

A 60 SX: especially conceived for cutting stainless steel and carbon steel. Free from sulphur, iron and chlorine. Excellent cut, fast, cold, long durability.

50x1,3x8,00		A 60 SX	80 m/s	G1621	100pcs
75x1,3x9,53		A 60 SX	80 m/s	G1622	100pcs
100x1,3x16,00		A 60 SX	80 m/s	G1623	50pcs
115x1,3x22,23	ZAC	A 60 SX	80 m/s	G1625 •	25pcs
115x1,6x22,23	ZAC	A 60 SX	80 m/s	G1626 •	25pcs
125x1,3x22,23	ZAC	A 60 SX	80 m/s	G1722 •	25pcs
125x1,6x22,23	ZAC	A 60 SX	80 m/s	G1723 •	25pcs
150x1,6x22,23	ZAC	A 60 SX	80 m/s	G1724 •	50pcs
180x2,0x22,23	ZAC	A 60 SX	80 m/s	G1725 •	50pcs
230x2,0x22,23	ZAC	A 60 SX	80 m/s	G1726 •	50pcs

DISC DURABILITY 
CUTTING SPEED 
CLEAN CUT 

PATENTED



ZAC

On both sides of **ZAC** very thin "helical patterns" are pressed (GLOBE patent) that help developing lower friction and reduced heat, enhancing cutting speed and rigidity.

 **STEEL**

A 60 S: especially conceived for steel ensure long durability and make work more efficient reducing costs and speeding up processing times.

75x1,3x9,53		A 60 S	80 m/s	G1612	100pcs
100x1,3x16,00		A 60 S	80 m/s	G1613	100pcs
115x1,0x22,23	ZIP-HP	A 60 S	80 m/s	G1614 •	25pcs
115x1,3x22,23	ZAC	A 60 S	80 m/s	G1615 •	25pcs
115x1,6x22,23	ZAC	A 60 S	80 m/s	G1616 •	25pcs
125x1,0x22,23	ZIP-HP	A 60 S	80 m/s	G1711 •	25pcs
125x1,3x22,23	ZAC	A 60 S	80 m/s	G1712 •	25pcs
125x1,6x22,23	ZAC	A 60 S	80 m/s	G1713 •	25pcs
150x1,6x22,23	ZAC	A 60 S	80 m/s	G1714 •	25pcs
180x2,0x22,23	ZAC	A 60 S	80 m/s	G1715 •	50pcs
230x2,0x22,23	ZAC	A 60 S	80 m/s	G1716 •	50pcs

DISC DURABILITY 
CUTTING SPEED 
CLEAN CUT 

 **ALUMINIUM**

A 60 QAL: for cutting aluminium and other soft non ferrous materials (copper, brass...). Thanks to the special mixture, the disc does not get clogged and is always sharp. Fast cut and excellent durability.

115x1,3x22,23	ZAC	A 60 QAL	80 m/s	G1645 •	25pcs
125x1,3x22,23	ZAC	A 60 QAL	80 m/s	G1742 •	25pcs

DISC DURABILITY 
CUTTING SPEED 
CLEAN CUT 

CUTTING

MATERIAL	DIMENSIONS (diam - spess - foro) mm	HARDNESS	USE SPEED	ARTICLE CODE	
----------	--	----------	--------------	-----------------	---

PLUS LINE    **STONE**

C 60 S: for cutting marble, stones, bricks, concrete, etc. Medium durability.

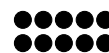
DISC DURABILITY
CUTTING SPEED

115x1,0x22,23	ZIP HP	C 60 S	80 m/s	G1634 •	25pcs
125x1,0x22,23	ZIP HP	C 60 S	80 m/s	G1731 •	25pcs

 **TITANIUM**

C 60 S-Titanium: very precise in cutting of titanium and bronze. Fast cut and long durability. A GLOBE specialty in a field with the most advanced technology.

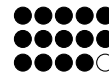
DISC DURABILITY
CUTTING SPEED
CLEAN CUT

NEW 125x1,3x22,23	ZAC	C 60 S	80 m/s	G1752 •	25pcs
--------------------------	-----	--------	--------	---------	-------

MATERIAL	DIMENSIONS (diam - thick. - bore) mm	HARDNESS	USE SPEED	ARTICLE CODE	
----------	---	----------	--------------	-----------------	--

EVOLUTION LINE   **STAINLESS
STEEL AND
STEEL**

A 60 SX: for cutting steel and stainless steel. Free from Fe, S, Cl compounds (certificate available). Fast and cold cut, long durability.

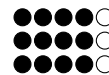
DISC DURABILITY
CUTTING SPEED
CLEAN CUT

NEW 115x1,0x22,23		A 60 SX	80 m/s	G1624 EVO •	25pcs
NEW 115x1,3x22,23		A 60 SX	80 m/s	G1625 EVO •	25pcs
NEW 115x1,6x22,23		A 60 SX	80 m/s	G1626 EVO •	25pcs
NEW 125x1,0x22,23		A 60 SX	80 m/s	G1721 EVO •	25pcs
NEW 125x1,3x22,23		A 60 SX	80 m/s	G1722 EVO •	25pcs
NEW 125x1,6x22,23		A 60 SX	80 m/s	G1723 EVO •	25pcs
NEW 150x1,6x22,23		A 60 SX	80 m/s	G1724 EVO •	50pcs
NEW 180x2,0x22,23		A 60 SX	80 m/s	G1725 EVO •	50pcs
NEW 230x2,0x22,23		A 60 SX	80 m/s	G1726 EVO •	50pcs

EVOLUTION is the GLOBE intermediate range offering very good performances at a very good price.

MATERIAL	DIMENSIONS (diam - thick. - bore) mm	HARDNESS	USE SPEED	ARTICLE CODE	
----------	---	----------	--------------	-----------------	--

DYNAMIC LINE  **STAINLESS
STEEL AND
STEEL**

A 60 SX: for cutting steel and stainless steel. Free from Fe, S, Cl compounds (certificate available). Fast and cold cut, long durability.

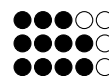
DISC DURABILITY
CUTTING SPEED
CLEAN CUT

NEW 115x1,0x22,23		A 60 SX	80 m/s	G1614 DYN •	100pcs
NEW 115x1,3x22,23		A 60 SX	80 m/s	G1615 DYN •	100pcs
NEW 115x1,6x22,23		A 60 SX	80 m/s	G1616 DYN •	100pcs
NEW 125x1,0x22,23		A 60 SX	80 m/s	G1711 DYN •	100pcs
NEW 125x1,3x22,23		A 60 SX	80 m/s	G1712 DYN •	100pcs
NEW 125x1,6x22,23		A 60 SX	80 m/s	G1713 DYN •	100pcs
NEW 180x2,0x22,23		A 60 SX	80 m/s	G1715 DYN •	50pcs
NEW 230x2,0x22,23		A 60 SX	80 m/s	G1716 DYN •	50pcs

The **DYNAMIC** line is the GLOBE proposal to big distribution for all those who pay attention to cheapness and performance, a feature of GLOBE production.























TYPE 41

STANDARD FLAT CUTTING DISCS FOR PORTABLE ANGLE GRINDERS



CUTTING

GLOBE offers a wide range of standard flat cutting wheels of 2,5 mm thickness for portable grinders. Of great importance is the right choice for the work to be done. This range is suitable for heavy works for which thin discs are not the right product. Choosing the right product is essential. The different types of abrasives, different binders and different hardnesses are the fundamentals to always supply the maximum performance to any application. The several combinations offered by GLOBE range always allow to find the best product for the work to be carried out.

MATERIAL	DIMENSIONS (diam - thick. - bore) mm	HARDNESS	USE SPEED	ARTICLE CODE		PLUS LINE   
 STAINLESS STEEL AND STEEL	A 30-36 Q: for standard use in cutting iron and steel. Good cutting capacity and medium durability. Usable also on stainless steel.					DISC DURABILITY 
	230x2,5x22,23	A 30-36 Q	80 m/s	G1415 •	25pcs	CUTTING SPEED 
 STEEL	A 30-36 R: for cutting iron and steel. Offers a good cutting capacity and long durability. Excellent resistance to stress.					CLEAN CUT 
	100x2,5x16,00	A 30-36 R	80 m/s	G1421	50pcs	DISC DURABILITY 
	115x2,5x22,23	A 30-36 R	80 m/s	G1422	50pcs	CUTTING SPEED 
	125x2,5x22,23	A 30-36 R	80 m/s	G1423 •	50pcs	CLEAN CUT 
	230x2,5x22,23	A 30-36 R	80 m/s	G1425 •	25pcs	
 STEEL	A 30-36 T: manufactured with special resins and abrasives. Offers an excellent cutting capacity, long durability and excellent resistance to the most heavy stress.					
	180x2,5x22,23	A 30-36 T	80 m/s	7325115370100	25pcs	
	230x2,5x22,23	A 30-36 T	80 m/s	G1435	25pcs	
 STAINLESS STEEL	Z 30-36 SX: wheel containing alumina zirconia for use on alloy steel and stainless steel. Without sulphur, chlorine and iron compounds (certification available). Excellent cold and fast cutting, long durability.					DISC DURABILITY 
	115x2,5x22,23	Z 30-36 SX	80 m/s	G1442	50pcs	CUTTING SPEED 
	125x2,5x22,23	Z 30-36 SX	80 m/s	G1443 •	50pcs	CLEAN CUT 
	180x2,5x22,23	Z 30-36 SX	80 m/s	7325115360100	25pcs	
	230x2,5x22,23	Z 30-36 SX	80 m/s	G1445 •	25pcs	
 STONE	C 30-36 RE: for cutting marble, stone, bricks, concrete, etc. Excellent cutting capacity, medium hardness and long durability.					DISC DURABILITY 
	115x2,5x22,23	C 30-36 RE	80 m/s	G1452	50pcs	CUTTING SPEED 
	125x2,5x22,23	C 30-36 RE	80 m/s	G1453	25pcs	CLEAN CUT 
	230x2,5x22,23	C 30-36 RE	80 m/s	G1455 •	25pcs	

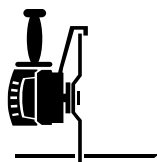

TYPE 42

DEPRESSED CENTER THIN CUTTING DISCS FOR PORTABLE ANGLE GRINDERS



GLOBE is proud to present its new **"NARROW DOME"**. This special shape, carefully conceived, of the depressed center minimizes the dimension of the dome to the advantage of the flat part. This allows to carry out more and deeper cuts obtaining the same durability and cutting capacity of a flat disc with the additional advantage of more rigidity and control thanks to the depressed center.

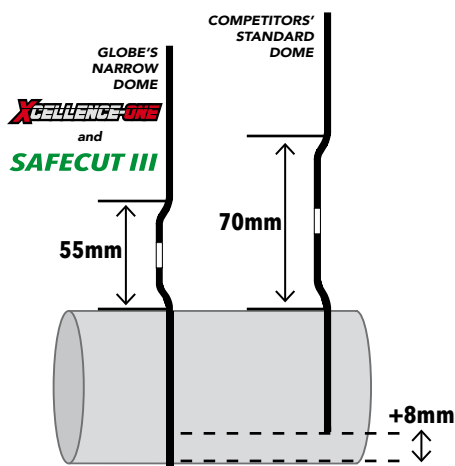

THE NARROW DOME

Increased cutting penetration force of the XCELLENCE ONE and SAFECUT (II and III) with "narrow dome" compared to a traditional depressed center disc.

BUILT-IN STEEL PROTECTION FLANGE

The metal dome **A** of the XCELLENCE ONE and SAFECUT discs guarantees more safety, avoids damages to the depressed center **B** and decreases vibrations thus increasing cutting precision and rigidity.



"GLOBE SPACER" ADVANTAGES

Thanks to the use of the special **"SPACER"** and to the depressed center shape, the machine shaft and the locknut do not stick out from the dome cavity thus enabling the operator to carry out flush cuts in a comfortable position.

The depressed center shape gives more rigidity than a flat disc, prevents bending allowing to make perfectly straight cuts.



SHAFT PROTRUSION WITH A STANDARD SPACER



NO SHAFT PROTRUSION THANKS TO THE SPECIAL HIGHER SPACER

NO
STANDARD FLANGE + FLAT CUTTING DISC

YES
GLOBE SPECIAL PLASTIC SPACER + DEPRESSED CENTER CUTTING DISC

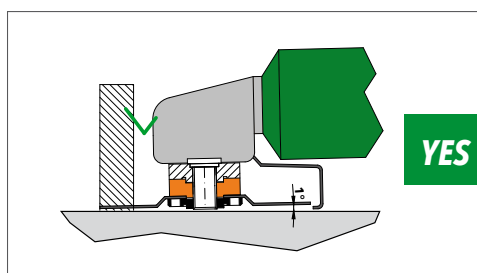
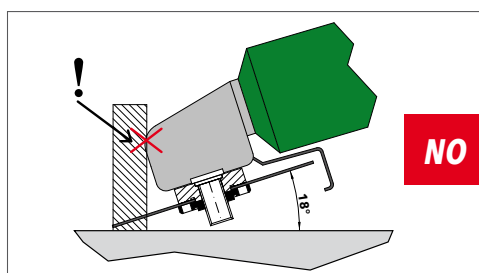

XCELLENCE-ONE

The ultra-thin **XCELLENCE-ONE** cutting disc is absolutely new in the market of resin-bonded abrasives; the special shape of this disc, called "narrow dome", allows a penetration in cutting never reached before with traditional depressed center discs. The extremely thin thickness (1 mm real) allows to make very thin cuts with the smallest formation of burrs and pitting on stainless steel sheet metals. **XCELLENCE-ONE** is perfect to carry out precise and straight cuts easily thanks to its higher rigidity, in spite of its reduced thickness. As all **GLOBE** products, also **XCELLENCE-ONE** complies with the highest safety standards, undergoes daily tests that guarantee a safe and excellent product.



The real 1,0 mm thickness of **XCELLENCE-ONE**



Absolute ease of handling maintaining **straight and net cut**.

THE ADVANTAGES OF XCELLENCE-ONE

- Cold, clean cut, without burrs or pittings
- Does not bend or vibrate. Easy straight and precise cuts
- Highest cutting speed
- Long-life mixture
- Safety also in deep cuts
- Unequalled cutting penetration thanks to the narrow dome
- Very easy handling
- Free from Fe,S,Cl <0,1%, does not contaminate steel
- Optimize the battery life of cordless grinders



The "narrow dome" with metal reinforcement gives unparalleled rigidity allowing to perform **straight and precise cuts** very easily.

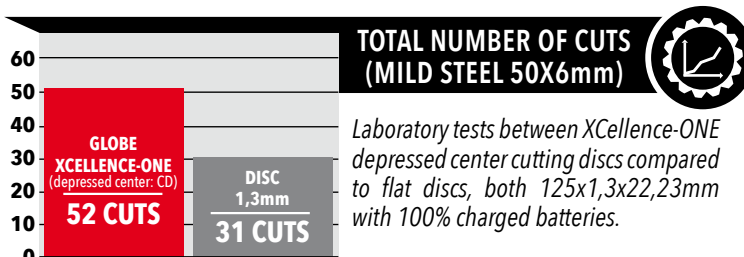

The "narrow dome" allows a **greater cutting depth**, while the very reduced thickness allows (on stainless steel sheets and profiles) thin cuts without burrs, discoloring and pittings.

MATERIAL	DIMENSIONS (diam - thick - bore) mm	HARDNESS	USE SPEED	ARTICLE CODE	
STAINLESS STEEL AND STEEL NEW NEW	ZA 60 SX: the new XCELLENCE-ONE cutting disc is free from Fe,S,Cl and for this reason it is perfect to cut STAINLESS STEEL .				
	115x1,0x22,23	X-ONE	ZA 60 SX	80 m/s	G1583 • 25pcs
	125x1,0x22,23	X-ONE	ZA 60 SX	80 m/s	G1584 • 25pcs

PLUS LINE

DISC DURABILITY CUTTING SPEED CLEAN CUT

STONE NEW	C 60 S: the new THIN CUT disc conceived to carry out very thin cuts of tile joints. THIN CUT cuts the broken tile without damaging the nearby ones. The ultra-thin thickness allows to cut even the narrower tile joints.				
	115x1,0x22,23	THIN CUT	C 60 S	80 m/s	G1593 25pcs

DISC DURABILITY CUTTING SPEED

"THIN CUT"
TILE INSTALLERS
HAVE A NEW COLLABORATOR:
USEFUL, PRECISE AND QUICK.



SAFECUT II and SAFECUT III

SAFECUT discs combine in a single disc the cutting depth of the flat disc with the extreme precision of the depressed center (DC) disc. The depressed center shape gives rigidity to the disc, preventing it from bending or vibrating.

Furthermore SAFECUT III offers in diameters 115 and 125 the innovating depressed center with **narrow dome** (Ø55 mm instead of 70 mm of conventional depressed center discs).

This means: increased cutting depth and longer life.

The safety guaranteed by GLOBE high standards is further increased by the metal dome that prevents damage of the depressed center and the consequent breakage of the disc that can occur when the surface of the dome rubs against the material being cut.

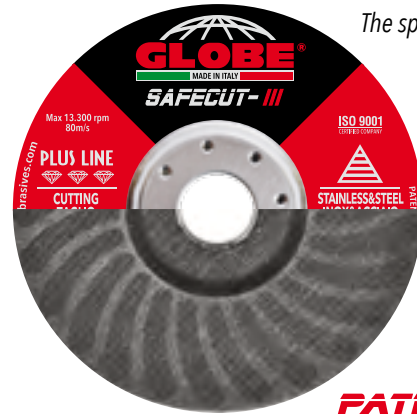

The special "RIBS" of SAFECUT.

PATENTED

THE ADVANTAGES OF SAFECUT II e III



- Straight and net cut
- Does not bend or vibrate
- Extreme precision
- Very high cutting speed
- Long durability
- Safety in deep cuts
- Cutting depth
- Ease of handling and versatility

Flush cut possible thanks to the depressed center shape and the use of the "SPACER".

MATERIAL	DIMENSIONS (diam - thick - bore) mm	HARDNESS	USE SPEED	ARTICLE CODE		PLUS LINE
----------	--	----------	--------------	-----------------	--	-----------

**STAINLESS
STEEL AND
STEEL**

NEW
NEW

A 60 SX: conceived for cutting stainless steel, alloy steel and hard steel. Free from Fe, S and Cl. Fast and cold cut, long durability.

75x1,0x9,53	SafeCut II	A 60 SX	80 m/s	G1547	100pcs
115x1,3x22,23	SafeCut III	A 60 SX	80 m/s	G1542 •	25pcs
125x1,3x22,23	SafeCut III	A 60 SX	80 m/s	G1543 •	25pcs
150x1,6x22,23	SafeCut II	A 60 SX	80 m/s	G1544	50pcs
180x2,0x22,23	SafeCut II	A 60 SX	80 m/s	G1545	50pcs
230x2,0x22,23	SafeCut II	A 60 SX	80 m/s	G1546 •	50pcs

DISC DURABILITY
CUTTING SPEED
CLEAN CUT

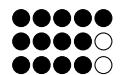

STEEL

NEW
NEW

A 60 S: suitable for cutting iron and steel. Fast and cold cut, long durability.

75x1,0x9,53	SafeCut II	A 60 S	80 m/s	G1537	100pcs
115x1,3x22,23	SafeCut III	A 60 S	80 m/s	G1532 •	25pcs
125x1,3x22,23	SafeCut III	A 60 S	80 m/s	G1533 •	25pcs
150x1,6x22,23	SafeCut II	A 60 S	80 m/s	G1534	50pcs
180x2,0x22,23	SafeCut II	A 60 S	80 m/s	G1535	50pcs
230x2,0x22,23	SafeCut II	A 60 S	80 m/s	G1536 •	50pcs

DISC DURABILITY
CUTTING SPEED
CLEAN CUT



ALUMINIUM

A 60 QAL: for cutting aluminium and other soft non-ferrous alloys.

230x2,0x22,23	SafeCut II	A 60 QAL	80 m/s	G1566 •	50pcs
---------------	------------	----------	--------	---------	-------

DISC DURABILITY
CUTTING SPEED
CLEAN CUT



MATERIAL	DIMENSIONS (diam - thick - bore) mm	HARDNESS	USE SPEED	ARTICLE CODE		EVOLUTION LINE
----------	--	----------	--------------	-----------------	--	----------------

**STAINLESS
STEEL AND
STEEL**

A 60 SX: conceived for cutting stainless steel, alloy steel and hard steel. Free from Fe, S and Cl. Fast and cold cut, long durability.

180x2,0x22,23	SafeCut	A 60 SX	80 m/s	G1545 EVO	25pcs
230x2,0x22,23	SafeCut	A 60 SX	80 m/s	G1546 EVO	25pcs

DISC DURABILITY
CUTTING SPEED
CLEAN CUT



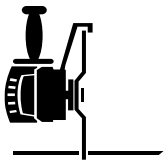

TYPE 42

STANDARD DEPRESSED CENTER CUTTING DISCS FOR PORTABLE MACHINES



CUTTING

The standard range of depressed center cutting discs for portable machines is perfectly suitable for any type of work thanks to the different thicknesses available and to the introduction of the "narrow dome" for diameters 115 and 125 (**HEAVY CUT** discs). Thickness, cutting depth and mixture (type of abrasive, binders, hardness) are fundamental for choosing the right product and are the basis to be able to always supply the best product for the work to carry out.



NARROW DOME FOR DEEPER CUTS

THE ADVANTAGES OF HEAVY CUT

- Disc portion usable: +15%
- More durability and more cuts
- More cutting depth (+7,5 mm)
- Perfect for difficult cuts
- High cutting speed
- Less waste, more saving
- Does not bend, does not vibrate

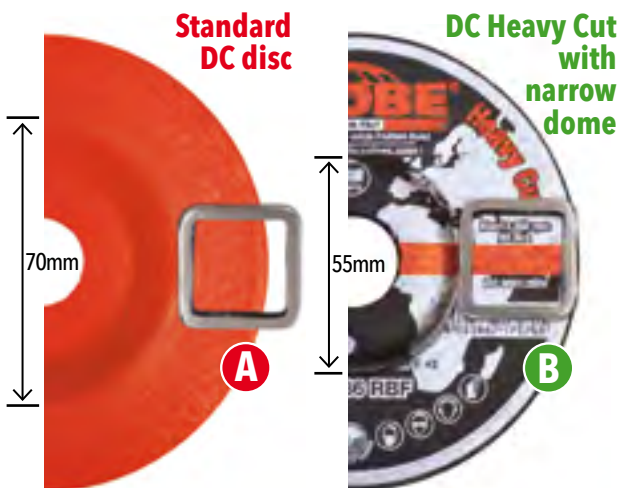

More surface available for cutting of **Heavy Cut (B)** compared to a **standard depressed center disc (A)** increases cutting penetration. Test made with 30x30x3mm tube.

HEAVY CUT (available in the **PLUS** and **DYNAMIC** version) is the innovating range of depressed center cutting discs with "NARROW DOME" conceived by GLOBE, available in diameters 115 mm and 125 mm with thicknesses from 2,5 mm up to 3,2 mm.

The idea of a "NARROW DOME" (only 55 mm of diameter) revolutionizes the market of this type of discs and gives the operator a definitively more performing tool in terms of cutting depth, number of cuts, durability, less waste and less costs.

GLOBE, always a step ahead in the research, developed a range of depressed center discs with a very small dome; this feature allows to have an increased cutting portion compared to traditional depressed center discs and guarantees a higher cutting speed.

The dome dimension is the minimum necessary to house the clamping flanges of grinders. GLOBE "HEAVY CUT" depressed center discs with "NARROW DOME" also guarantee excellent stability, precision, rigidity and the possibility of making flush cuts. The HEAVY CUT range with "NARROW DOME" is made with different mixtures to work on all the main materials. The INOX version is free from Fe, Cl, S.

MATERIAL	DIMENSIONS (diam - thick. - bore) mm	HARDNESS	USE SPEED	ARTICLE CODE	
----------	---	----------	--------------	-----------------	---

PLUS LINE 

**STAINLESS
STEEL AND
STEEL**

A 30-36 Q: for standard use, suitable for cutting iron and steel. Good cutting capacity, good durability. Usable also on stainless steel.

DISC DURABILITY
CUTTING SPEED
CLEAN CUT

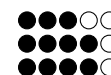

	100x3,2x16,00		A 30-36 Q	80 m/s	G1011	50pcs
NEW	115x3,2x22,23 Heavy Cut		A 30-36 Q	80 m/s	G1013 •	50pcs
NEW	125x3,2x22,23 Heavy Cut		A 30-36 Q	80 m/s	G1015 •	50pcs
	150x3,2x22,23		A 30-36 Q	80 m/s	G1016 •	50pcs
	180x3,2x22,23		A 30-36 Q	80 m/s	G1111	50pcs
	180x4,0x22,23		A 30-36 Q	80 m/s	6325136210100	50pcs
	230x3,2x22,23		A 30-36 Q	80 m/s	G1113 •	50pcs
	230x4,0x22,23		A 30-36 Q	80 m/s	6326036210100	25pcs

STEEL

A 30-36 R: suitable for cutting iron and steel, offers a good cutting capacity and a long durability.

DISC DURABILITY
CUTTING SPEED
CLEAN CUT



NEW	115x2,5x22,23 Heavy Cut		A 30-36 R	80 m/s	6323915310100	50pcs
NEW	125x2,5x22,23 Heavy Cut		A 30-36 R	80 m/s	6324215310100	50pcs
	180x2,5x22,23		A 30-36 R	80 m/s	6325115310100	50pcs
	230x2,5x22,23		A 30-36 R	80 m/s	6326015310200	50pcs
NEW	115x3,2x22,23 Heavy Cut		A 30-36 R	80 m/s	G1023 •	50pcs
NEW	125x3,2x22,23 Heavy Cut		A 30-36 R	80 m/s	G1025 •	50pcs
	150x3,2x22,23		A 30-36 R	80 m/s	G1026 •	50pcs
	180x3,2x22,23		A 30-36 R	80 m/s	G1121	50pcs
	180x4,0x22,23		A 30-36 R	80 m/s	6325136310100	50pcs
	230x3,2x22,23		A 30-36 R	80 m/s	G1123 •	50pcs
	230x3,6x22,23		A 30-36 R	80 m/s	G1124	50pcs
	230x4,0x22,23		A 30-36 R	80 m/s	6326036310100	25pcs

STEEL

A 30-36 T: manufactured with special resins and abrasives to obtain excellent cutting capacity, very long durability and excellent resistance to the most heavy stress.

DISC DURABILITY
CUTTING SPEED
CLEAN CUT



	230x2,5x22,23		A 30-36 T	80 m/s	G1132	50pcs
--	---------------	--	-----------	--------	-------	-------

**STAINLESS
STEEL**

A 30-36 QX: for cutting standard stainless steel. Good cutting capacity and good durability. Especially suitable for light structural works.

DISC DURABILITY
CUTTING SPEED
CLEAN CUT

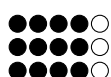

NEW	115x3,2x22,23 Heavy Cut		A 30-36 QX	80 m/s	6323924230100 •	50pcs
-----	-------------------------	--	------------	--------	-----------------	-------

**STAINLESS
STEEL**

Z 30-36 SX: with alumina zirconia and without sulphur, chlorine and iron (certificate available). It was especially conceived for use on alloy steel and stainless steel. Excellent fast and cold cutting capacity and long durability. Suitable for heavy structural works.

DISC DURABILITY
CUTTING SPEED
CLEAN CUT

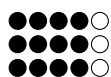

NEW	115x2,5x22,23 Heavy Cut		Z 30-36 SX	80 m/s	G1032 •	50pcs
NEW	125x2,5x22,23 Heavy Cut		Z 30-36 SX	80 m/s	G1034 •	50pcs
NEW	125x3,2x22,23 Heavy Cut		Z 30-36 SX	80 m/s	G1035	50pcs
	180x2,5x22,23		Z 30-36 SX	80 m/s	G1037	50pcs
	180x3,2x22,23		Z 30-36 SX	80 m/s	G1141	50pcs
	230x2,5x22,23		Z 30-36 SX	80 m/s	G1142 •	50pcs
	230x3,2x22,23		Z 30-36 SX	80 m/s	G1143 •	50pcs
	230x4,0x22,23		Z 30-36 SX	80 m/s	6326036360100	25pcs

MATERIAL	DIMENSIONS (diam - thick. - bore) mm	HARDNESS	USE SPEED	ARTICLE CODE	
----------	---	----------	--------------	-----------------	--

PLUS LINE



A 30-36 QG: for foundries of cast iron. Medium durability, excellent cutting capacity.

230x3,2x22,23	A 30-36 QG	80 m/s	G1333	50pcs
---------------	------------	--------	-------	-------

DISC DURABILITY	●●●●○
CUTTING SPEED	●●●●○
CLEAN CUT	●●●●○



Z 30-36 RG: special disc with alumina zirconia. Especially suitable for foundries of special cast iron and alloys. Excellent: cutting speed, long durability. resistance in heavy-duty works such as jagged fins and sharp corners.

230x3,2x22,23	ZC 30-36 RG	80 m/s	6326024320100	50pcs
230x3,5x22,23	Z 30-36 RG	80 m/s	G1343	25pcs
230x4,0x22,23	Z 30-36 RG	80 m/s	G1344	25pcs

DISC DURABILITY	●●●●●
CUTTING SPEED	●●●●○
CLEAN CUT	●●●●○



A 30-36 QAL: especially conceived for aluminium and other soft non ferrous metals (bronze, brass...). Fast and lubricated cutting thanks to the special mixture.

NEW	115x2,5x22,23	Heavy Cut	A 30-36 QAL	80 m/s	G1221 •	50pcs
NEW	115x3,2x22,23	Heavy Cut	A 30-36 QAL	80 m/s	G1222 •	50pcs
NEW	125x3,2x22,23	Heavy Cut	A 30-36 QAL	80 m/s	G1223 •	50pcs
	180x3,2x22,23		A 30-36 QAL	80 m/s	G1321	50pcs
	230x3,2x22,23		A 30-36 QAL	80 m/s	G1323 •	50pcs

DISC DURABILITY	●●●●○
CUTTING SPEED	●●●●○
CLEAN CUT	●●●●○



C 30-36 RE: for building industry. Suitable for marble, stones, bricks, concrete, etc. Excellent cutting capacity, medium hardness and long durability

NEW	115x3,2x22,23	Heavy Cut	C 30-36 RE	80 m/s	G1212 •	50pcs
NEW	125x3,2x22,23	Heavy Cut	C 30-36 RE	80 m/s	G1213 •	50pcs
	150x3,2x22,23		C 30-36 RE	80 m/s	G1214	50pcs
	180x3,2x22,23		C 30-36 RE	80 m/s	G1311	50pcs
	230x3,2x22,23		C 30-36 RE	80 m/s	G1313 •	50pcs

DISC DURABILITY	●●●●○
CUTTING SPEED	●●●●○



Creation of traces on reinforced concrete.

PIPELINER

PIPELINER is the cutting, grinding and beveling range designed for pipes fitting, notching and welding preparation.

These discs are specially conceived and reinforced for grinding joint welds between passes in pipeline construction. Free from iron, sulphur or chlorine (Fe, S, Cl), they do not contaminate stainless steel.

For more than 40 years GLOBE is supplying the OIL & GAS industry with specific abrasive products for general and special applications. GLOBE offers a full range of products for every kind of OIL & GAS applications such as pipelines constructions, onshore and offshore installations, pipe and vessel manufacturing, maintenance and overhauling.



APPLICATIONS AND ADVANTAGES OF PIPELINER

- All operations of: beveling, light grinding, notching, cleaning and preparation of weld beads
- Outstanding performance in pipeline construction
- Long durability and high safety standard

MATERIAL	DIMENSIONS (diam - thick. - bore) mm	HARDNESS	USE SPEED	ARTICLE CODE	
----------	---	----------	--------------	-----------------	--

PLUS LINE



Specific mixtures that can be used both on carbon steel and stainless steel. Perfect for PIPELINE operations.

NEW	115x2,5x22,23	A 36 R	80 m/s	G1144 •	50pcs
NEW	125x2,5x22,23	A 36 R	80 m/s	G1145 •	50pcs
NEW	150x3,5x22,23	A 24 R	80 m/s	G1146	50pcs
NEW	180x4,0x22,23	A 20 R	80 m/s	G1147	50pcs

DISC DURABILITY	●●●●○
CUTTING SPEED	●●●●○
CLEAN CUT	●●●●○

MATERIAL	DIMENSIONS (diam - thick. - bore) mm	HARDNESS	USE SPEED	ARTICLE CODE	
----------	---	----------	--------------	-----------------	---

 **STEEL**

A 30-36 R: suitable for cutting iron and steel, combines a good cutting capacity with a long durability.

DISC DURABILITY 
 CUTTING SPEED 
 CLEAN CUT 

NEW	115x3,0x22,23 Heavy Cut	A 30-36 R	80 m/s	G1023 DYN •	50pcs
NEW	125x3,0x22,23 Heavy Cut	A 30-36 R	80 m/s	G1025 DYN •	50pcs
	180x3,0x22,23	A 30-36 R	80 m/s	G1121 DYN	50pcs
	230x3,0x22,23	A 30-36 R	80 m/s	G1123 DYN •	50pcs

• = articles always in stock

FLAT AND DEPRESSED CENTER CUTTING DISCS

Ø > 230mm

CUTTING (Ø > 230mm)



TYPE 41

32

STANDARD FLAT AND EXTRA REINFORCED (SECURCUT)

FOR STATIONARY MACHINES



TYPE 41

34

ALLCUT

FOR MACHINES WITH COMBUSTION ENGINE

35

RAILCUT LINE FOR RAILWAYS CUTTING
FOR MACHINES WITH COMBUSTION ENGINE



TYPE 41

36

CHOPCUT

FOR LIGHT STATIONARY MACHINES



TYPE 41

37

LABCUT

FOR CUTTING TEST PIECES WITH LABORATORY MACHINES



TYPE 42

38

DEPRESSED CENTER

FOR SWING-FRAME OR STATIONARY MACHINES

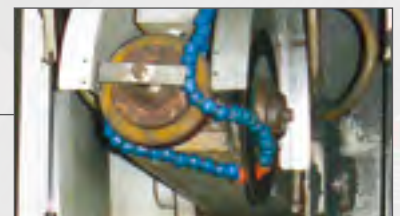

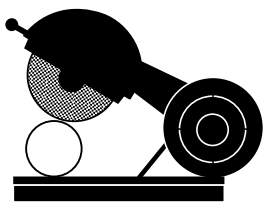

TYPE 41

STANDARD FLAT AND SECURCUT CUTTING DISCS (Ø>230mm) FOR STATIONARY MACHINES

CUTTING (Ø>230mm)



GLOBE cutting discs for stationary machines offer a wide range of products for cutting the most different types of materials and are available in diameters from 300 mm up to 800 mm with thicknesses that vary from 3 to 9 mm. Possibility to change the bore size according to customers' needs. Particular care is taken in balancing these discs to obtain a product without vibrations.

MATERIAL	DIMENSIONS (diam - thick. - bore) mm	HARDNESS	USE SPEED	ARTICLE CODE		PLUS LINE
----------	---	----------	--------------	-----------------	--	-----------

STEEL

A 30-36 R: standard use, good cutting capacity and medium durability. Suitable for iron and steel.

DISC DURABILITY
 CUTTING SPEED
 CLEAN CUT

300x3,5x20,00	A 30-36 R	100 m/s	G2314 20	25pcs
300x4,0x22,23	A 30-36 R	80 m/s	G2314	25pcs
300x4,0x25,40	A 30-36 R	80 m/s	G2314 25	25pcs
300x4,0x30,00	A 30-36 R	80 m/s	G2314 30 •	25pcs
300x4,0x40,00	A 30-36 R	80 m/s	G2314 40	25pcs
350x4,0x22,23	A 30-36 R	80 m/s	G2315	25pcs
350x4,0x25,40	A 30-36 R	80 m/s	G2315 25	25pcs
350x4,0x30,00	A 30-36 R	80 m/s	G2315 30 •	25pcs
350x4,0x40,00	A 30-36 R	80 m/s	G2315 40	25pcs
400x4,5x25,40	A 30-36 R	80 m/s	G2411 25	10pcs
400x4,5x32,00	A 30-36 R	80 m/s	G2411 32	10pcs
400x4,5x40,00	A 30-36 R	80 m/s	G2411 40 •	10pcs
500x5,0x25,40	A 30-36 R	80 m/s	G2412 25	10pcs
500x5,0x40,00	A 30-36 R	80 m/s	G2412 40	10pcs
600x6,0x60,00	A 30-36 R	80 m/s	G2413	10pcs
600x 8,0x60,00	A 30-36 R	80 m/s	G2414	10pcs
700x7,0x60,00	A 30-36 R	80 m/s	8687954470101	10pcs

STEEL

A 24 S: high performance, high cutting capacity and long durability. This type of cutting disc is especially suitable for cutting profiles in the building industry and for heavy structural works in general.

DISC DURABILITY
 CUTTING SPEED
 CLEAN CUT

300x4,0x22,23	A 24 S	80 m/s	G2324	25pcs
300x4,0x25,40	A 24 S	80 m/s	G2324 25	25pcs
300x4,0x30,00	A 24 S	80 m/s	G2324 30	25pcs
350x4,0x25,40	A 24 S	80 m/s	G2325 25	25pcs
350x4,0x30,00	A 24 S	80 m/s	G2325 30	25pcs
350x4,0x40,00	A 24 S	80 m/s	G2325 40	25pcs
400x4,5x25,40	A 24 S	80 m/s	G2421 25	10pcs
400x4,5x40,00	A 24 S	80 m/s	G2421 40	10pcs
500x5,0x25,40	A 24 S	80 m/s	G2422 25	10pcs
500x5,0x40,00	A 24 S	80 m/s	G2422 40	10pcs

• = articles always in stock

MATERIAL	DIMENSIONS (diam - thick. - bore) mm	HARDNESS	USE SPEED	ARTICLE CODE	
----------	---	----------	--------------	-----------------	---

PLUS LINE   

 **STEEL**

AN 36 S: For cutting steel and alloy steel castings especially in lost-wax casting where the work-piece is fed manually. High stability and accurate balancing enhance excellent cutting and cooling capacities.

DISC DURABILITY 
CUTTING SPEED 
CLEAN CUT 

300x2,5x22,23	AN 36 S	80 m/s	G2332	25pcs
300x2,5x25,40	AN 36 S	80 m/s	G2332 25 T22	25pcs
300x2,5x30,00	AN 36 S	80 m/s	G2332 30 •	25pcs
300x3,0x25,40	AN 36 S	80 m/s	G2333 •	25pcs
300x3,0x30,00	AN 36 S	80 m/s	G2333 30 •	25pcs
350x3,0x25,40	AN 36 S	80 m/s	G2335 25	25pcs

 **STEEL**

A 30 T and ZA 24 T: the particularly hard mixture allows to carry out a very high number of cuts. Especially suitable for cutting light stalks in foundries.

DISC DURABILITY 
CUTTING SPEED 
CLEAN CUT 

300x3,0x25,40	A 30 T	80 m/s	G2363	25pcs
350x3,0x25,40	A 30 T	80 m/s	G2365	25pcs
350x3,0x25,40	ZA 24 T	80 m/s	G2366 25	25pcs

 **STAINLESS
STEEL**

A 30-36 RX: thanks to the high cutting capacity and cooling, it is suitable for alloy steel. Free from Iron, sulphur and chlorine compounds.

DISC DURABILITY 
CUTTING SPEED 
CLEAN CUT 

300x4,0x25,40	A 30-36 RX	80 m/s	G2344 25	25pcs
300x4,0x30,00	A 30-36 RX	80 m/s	G2344 30 •	25pcs
300x4,0x40,00	A 30-36 RX	80 m/s	G2344 40	25pcs
350x4,0x25,40	A 30-36 RX	80 m/s	G2345 25	25pcs
350x4,0x30,00	A 30-36 RX	80 m/s	G2345 30 •	25pcs
350x4,0x40,00	A 30-36 RX	80 m/s	G2345 40	25pcs
400x4,5x25,40	A 30-36 RX	80 m/s	G2431 25	25pcs
400x4,5x40,00	A 30-36 RX	80 m/s	G2431 40	25pcs
500x5,0x25,40	A 30-36 RX	80 m/s	G2432 25	25pcs
500x5,0x40,00	A 30-36 RX	80 m/s	G2432 40	25pcs

 **STEEL**

A 30-36 S (SECURCUT): EXTRA REINFORCED discs, expressly conceived to meet the needs of full safety for operators of cut-off machines with manual drive of the part (for example cutting of fusion "bunches" in foundries). Besides the high cutting capacity and long durability, they are ultra-resistant to side stress thanks to the fiberglass reinforcements.

DISC DURABILITY 
CUTTING SPEED 
CLEAN CUT 

NEW NEW 300x4,0x25,40	A 30-36 S	100 m/s	G2223 25	25pcs
350x4,0x25,40	A 30-36 S	100 m/s	G2224 25	25pcs

 **STAINLESS
STEEL AND
STEEL**

AZ 24S 107: cutting discs especially conceived for cutting stainless steel and cast-iron stalks and for heavy cuts. Characterized by a very high performance and cutting speed.

DISC DURABILITY 
CUTTING SPEED 
CLEAN CUT 

400x4,7x25,40	AZ 24S 107	80 m/s	8527236299100	25pcs
---------------	------------	--------	---------------	-------

 **STONE**

C 30-36 S: universal use for cutting of special materials such as building materials, stone, marble, plastic, aluminium and in general all non-ferrous alloys.

DISC DURABILITY 
CUTTING SPEED 

300x4,0x22,23	C 30-36 S	80 m/s	G2354	25pcs
300x4,0x20,00	C 30-36 S	80 m/s	G2354 20	25pcs
300x4,0x25,40	C 30-36 S	80 m/s	G2354 25	25pcs
300x4,0x30,00	C 30-36 S	80 m/s	G2354 30	25pcs
300x4,0x40,00	C 30-36 S	80 m/s	G2354 40	25pcs
300x4,0x50,80	C 30-36 S	80 m/s	G2354 50	25pcs
350x4,0x25,40	C 30-36 S	80 m/s	G2355 25	25pcs
350x4,0x40,00	C 30-36 S	80 m/s	G2355 40	25pcs
400x4,5x25,40	C 30-36 S	80 m/s	G2441 25	10pcs
400x4,5x40,00	C 30-36 S	80 m/s	G2441 40	10pcs
500x5,0x25,40	C 30-36 S	80 m/s	G2442 25	10pcs
500x5,0x40,00	C 30-36 S	80 m/s	G2442 40	10pcs
600x5,0x50,00	C 30-36 S	80 m/s	G2442 50	10pcs
600x6,0x60,00	C 30-36 S	80 m/s	G2443	10pcs
600x8,0x60,00	C 30-36 S	80 m/s	G2444	10pcs

 **STONE**

C 24 S: special cutting disc manufactured in diameters from 600 up to 800 mm for cutting beams and prestressed reinforced concrete workpieces. Especially suitable for cutting railway sleepers.

DISC DURABILITY 
CUTTING SPEED 

700x8,0x60,00	C 24 S	100 m/s	8687954470102	10pcs
800x9,0x60,00	C 24 S	80 m/s	G2455	10pcs

CUTTING (Ø > 230mm)



DISCS FOR PORTABLE GRINDERS WITH COMBUSTION ENGINE:

- **ALLCUT:** FOR GENERAL CUTTING
- **RAILCUT:** FOR CUTTING RAILWAY TRACKS

TYPE 41

CUTTING (Ø > 230mm)



REINFORCED FOR 100m/s

GLOBE cutting range with portable grinders with combustion engine includes the new rail cutting discs **RAILCUT I** and **RAILCUT II (FAST CUT and LONG LIFE)** and discs for general cutting of ferrous metals and special materials (**ALLCUT** line): universal cutting and building materials). These discs, duly reinforced to work at 100 m/sec in maximum safety, are widely used in construction yards: industrial assembly, construction sites, demolitions, road and railway emergency services. Available in different diameters (from 300 to 400 mm) and with different specifications of use.

MATERIAL	DIMENSIONS (diam - thick. - bore) mm	HARDNESS	USE SPEED	ARTICLE CODE		PLUS LINE	
STEEL	A 30-36 S (ALLCUT): universal use for any type of cut. Extremely safe and with high cutting capacity, particularly suitable in construction yards (industrial assemblies, demolition of cars, road and railway emergency services, etc.).						DISC DURABILITY
							CUTTING SPEED
							CLEAN CUT
	300x4,0x20,00	A 30-36 S	100 m/s	G2211 20 •	25pcs		
	300x4,0x22,23	A 30-36 S	100 m/s	G2211 22 •	25pcs		
	300x4,0x25,40	A 30-36 S	100 m/s	G2211 25 •	25pcs		
	350x4,0x20,00	A 30-36 S	100 m/s	G2212 20 •	25pcs		
350x4,0x22,23	A 30-36 S	100 m/s	G2212 22	25pcs			
350x4,0x25,40	A 30-36 S	100 m/s	G2212 25	25pcs			

MATERIAL	DIMENSIONS (diam - thick. - bore) mm	HARDNESS	USE SPEED	ARTICLE CODE		DYNAMIC LINE	
STONE	C 30-36 S (ALLCUT): universal use for the building industry. Suitable for stones, plastic, aluminium, non-ferrous alloys, etc. to be used in open-air construction yards in maximum safety.						DISC DURABILITY
							CUTTING SPEED
							CLEAN CUT
	300x4,0x20,00	C 30-36 S	100 m/s	G2221 20	25pcs		
	300x4,0x22,23	C 30-36 S	100 m/s	G2221 22	25pcs		
	300x4,0x25,40	C 30-36 S	100 m/s	G2221 25	25pcs		
	350x4,0x20,00	C 30-36 S	100 m/s	G2222 20	25pcs		
350x4,0x25,40	C 30-36 S	100 m/s	G2222 25	25pcs			

MATERIAL	DIMENSIONS (diam - thick. - bore) mm	HARDNESS	USE SPEED	ARTICLE CODE		DYNAMIC LINE	
STAINLESS STEEL AND STEEL	A 30-36 S (ALLCUT): universal use for any type of cut. Safe and with good cutting capacity, particularly suitable for construction yards.						DISC DURABILITY
							CUTTING SPEED
							CLEAN CUT
	NEW 300x4,0x32,00	A 30-36 S	100 m/s	G2211 32 DYN	25pcs		
NEW 350x4,0x25,40	A 30-36 S	100 m/s	G2212 25 DYN	25pcs			
NEW 350x4,0x32,00	A 30-36 S	100 m/s	G2212 32 DYN	25pcs			

• = articles always in stock



CUTTING (Ø > 230mm)

RAILCUT is the GLOBE range specially designed for professional cutting of railway tracks. RAILCUT cutters allow an extremely fast, straight, precise, balanced and "cold" cut: thanks to these features, RAILCUT cutters passed very rigorous and strict tests of the most important railway companies in the world.

RAILCUT I is the standard high quality version: the corundum mixture provides a fast and precise cut, with a moderate wear of the disc.

MATERIAL	DIMENSIONS (diam - thick. - bore) mm	HARDNESS	USE SPEED	ARTICLE CODE		PLUS LINE	DISC DURABILITY	CUTTING SPEED	CLEAN CUT
STEEL	A 24 R (RAILCUT I): cutting wheels designed and reinforced for guided cutting of railway tracks with special machines with combustion engine. Highly balanced wheels with great penetration and cooling power. They allow fast and straight cuts. High-tech and safe tool, allow a highly cost-effective work.						●●●○○	●●●○○	●●●○○
	300x4,0x22,23	A 24 R	100 m/s	G2111 22 •	25pcs				
	300x4,0x25,40	A 24 R	100 m/s	G2111 25	25pcs				
	350x4,0x25,40	A 24 R	100 m/s	G2112 25	25pcs				
	400x4,5x25,40	A 24 R	100 m/s	G2113 25	10pcs				

RAILCUT II is the new arrival in GLOBE wide product range. Resulting from a further development, from the use of the most advanced and performing raw materials as well as from hundreds of tests performed on site of different types of rail. **RAILCUT II**, the state of the art in this sector, includes 2 lines:

MATERIAL	DIMENSIONS (diam - thick. - bore) mm	HARDNESS	USE SPEED	ARTICLE CODE		PLUS LINE	DISC DURABILITY	CUTTING SPEED	CLEAN CUT
STEEL	A 24 R (RAILCUT II LONG LIFE): In addition to being fast, it provides a considerable number (the double compared to the best discs on the market) of precise, straight and cold cuts.						●●●●●	●●●○○	●●●○○
NEW	350x4,0x25,40 LONG LIFE	A 24 R	100 m/s	G2114 25 •	25pcs				
NEW	400x4,5x25,40 LONG LIFE	A 24 R	100 m/s	G2115 25	10pcs				

STEEL	A 24 R (RAILCUT II FAST CUT): is 30% faster preventing overheating of the metal piece. Cut is perfectly straight and precise. Specifically designed for on-site works (directly on railway line) where precision and speed are extremely important. Also suitable for cutting the hardest and heaviest tracks. Like all GLOBE products, the RAILCUT RANGE discs comply with the highest safety standards (EN12413) and are tested batch by batch to guarantee a safe, reliable and excellent product.						●●●●●	●●●●●	●●●●●
NEW	350x4,0x25,40 FAST CUT	A 24 R	100 m/s	G2116 25 •	25pcs				
NEW	400x4,5x25,40 FAST CUT	A 24 R	100 m/s	G2117 25	10pcs				

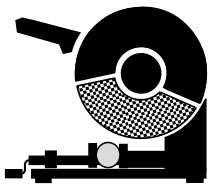

CHOPCUT FLAT DISCS FOR LIGHT BENCH GRINDERS

TYPE 41

CUTTING (Ø > 230mm)



CHOPCUT cutting discs for light stationary machines allow to cut sections' profiles, tubes and also full sections with diameter up to 30/40 mm. They combine a long durability with an excellent cutting capacity thanks to their low thickness. Particular care is taken in balancing these discs to ensure comfortable cutting operations and a good grinder stability without vibrations.

MATERIAL	DIMENSIONS (diam - thick. - bore) mm	HARDNESS	USE SPEED	ARTICLE CODE		PLUS LINE	DISC DURABILITY CUTTING SPEED CLEAN CUT
STEEL	A 30-36 S (CHOPCUT): for iron and steel. Universal cutting discs, long durability and high cutting speed. Suitable for cutting sections' profiles and medium sized full sections.						
	300x2,5x25,40	A 30-36 S	80 m/s	G1911 •	25pcs		
	350x3,0x25,40	A 30-36 S	80 m/s	G1912 •	25pcs		
	400x3,2x25,40	A 30-36 S	80 m/s	G1913	10pcs		

STAINLESS STEEL	A 30-36 SX (CHOPCUT): for stainless steel, free from iron, sulphur and chlorine compounds (certification available). Long durability and excellent cutting capacity. Suitable for cutting sections' profiles and medium sized full sections.						
	300x2,5x25,40	A 30-36 SX	80 m/s	G1911-INOX	25pcs		
	350x3,0x25,40	A 30-36 SX	80 m/s	G1912-INOX	25pcs		
	400x3,2x25,40	A 30-36 SX	80 m/s	G1913-INOX	10pcs		

MATERIAL	DIMENSIONS (diam - thick. - bore) mm	HARDNESS	USE SPEED	ARTICLE CODE		DYNAMIC LINE	DISC DURABILITY CUTTING SPEED CLEAN CUT
STEEL	A 30-36 S: universal cutting discs, suitable for cutting thin sections' profiles and full sections.						
NEW	300x4,0x25,40	A 30-36 S	80 m/s	G1911 DYN	25pcs		
NEW	350x4,0x25,40	A 30-36 S	80 m/s	G1912 DYN	25pcs		

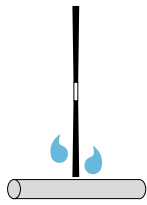

TYPE 41

LABCUT DISCS FOR CUTTING TEST PIECES WITH FULLY ENCLOSED MACHINES

CUTTING (Ø > 230mm)



Built with light reinforcements for cutting test pieces exclusively with enclosed machines, also with coolant. Thanks to their high cutting capacity they do not overheat workpieces and allow a precise, fast and cold cut. Available in diameters 250, 300 and 350 mm, their mixture does not contain iron, sulphur and chlorine compounds.

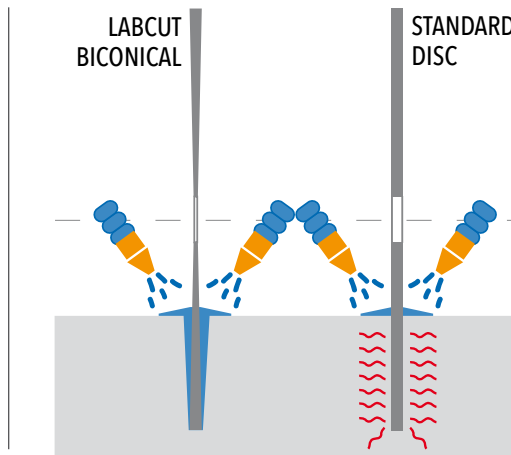
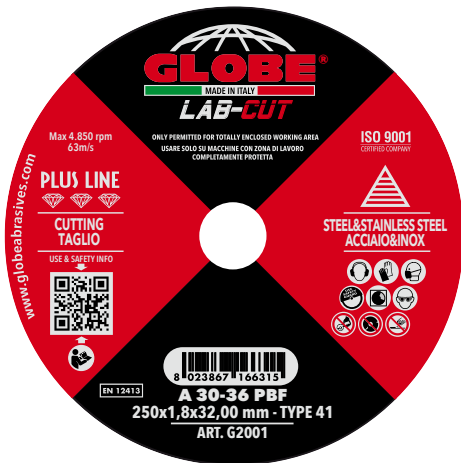

The special bi-conical shape of **LABCUT** wheels helps coolant to penetrate in the cutting area, enhancing cooling and allowing the non-alteration of steel's micro crystalline structure.

MATERIAL	DIMENSIONS (diam - thick. - bore) mm	HARDNESS	USE SPEED	ARTICLE CODE		PLUS LINE
----------	---	----------	--------------	-----------------	--	-----------

**STAINLESS
STEEL AND
STEEL**

A 30-36 P (LABCUT): wheels for cutting alloy steel test pieces, chrome plated, cemented or adjusted bars and for metalographic examination. Suitable also for cutting with coolant. Mixture without iron, sulphur and chlorine (certification available).

DISC DURABILITY
CUTTING SPEED
CLEAN CUT

250x1,5x32,00	A 30-36 P	63 m/s	G2001-1,5	10pcs
250x1,8x32,00	A 30-36 P	63 m/s	G2001	10pcs
300x2,5x32,00	A 30-36 P	63 m/s	G2011	10pcs
350x3,0x32,00	A 30-36 P	63 m/s	G2012	10pcs

CUTTING (Ø > 230mm)

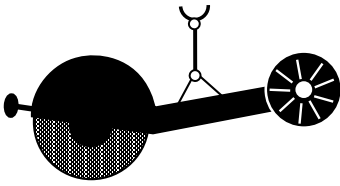

TYPE 42

DEPRESSED CENTER WHEELS FOR STATIONARY OR SWING-FRAME GRINDERS



These cutting wheels are largely and effectively used in foundries for cutting ferrous and non-ferrous metals. The depression in the wheel fully houses the shaft and the locking nut so that operators can cut very close to feedheads, avoiding costly operations to remove thick layers of residual material. The special depressed center shape also gives more stability and rigidity to the disc. Its careful balancing prevents disturbing vibrations in the handle bar and significantly improves operator's comfort and disc's performance. Available in diameters 400, 500 and 600mm with thicknesses from 5,0 to 7,0mm.



Depressed center shape allowing to carry out flush cuts.

MATERIAL	DIMENSIONS (diam - thick - bore) mm	HARDNESS	USE SPEED	ARTICLE CODE		PLUS LINE	DISC DURABILITY	CUTTING SPEED	CLEAN CUT
STEEL	A 30-36 R: standard applications, good cutting capacity and average durability. Suitable to be used on iron and steel. The depressed center shape gives high cutting stability and precision.						●●●●○	●●●●●	●●●●○
	600x7,0x76,50	A 30-36 R	100 m/s	G2415 CD	10pcs		●●●●●	●●●●○	●●●●○
STEEL	A 24 S: high performance, high cutting capacity and long durability. For standard applications, especially suitable to cut building sections and for structural works. For iron and steel.						●●●●●	●●●●○	●●●●○
	400x5,0x76,50	A 24 S	100 m/s	8727235360100	10pcs		●●●●●	●●●●○	●●●●○
	500x5,0x76,50	A 24 S	100 m/s	8727545360100	10pcs		●●●●●	●●●●○	●●●●○
	600x7,0x76,50	A 24 S	100 m/s	G2425 CD	10pcs		●●●●●	●●●●○	●●●●○
STONE	C 24 S: special cutting wheel, from diameter 600 up to 800 mm for cutting beams and reinforced concrete workpieces.						●●●●○	●●●●●	●●●●○
	500x5,0x76,50	C 24 S	100 m/s	G2442 CD	10pcs		●●●●●	●●●●○	●●●●○

● = articles always in stock



TYPE 27

40

COMBI "CERAMIC POWER"

SPECIAL DEPRESSED CENTRE CERAMIC DISCS
FOR CUTTING/GRINDING
(FOR PORTABLE ANGLE GRINDERS)



TYPE 27

41

COMBI EXTRA AND COMBI STANDARD

SPECIAL AND STANDARD DEPRESSED CENTER DISCS
FOR CUTTING/GRINDING AND CAULKING
(FOR PORTABLE ANGLE GRINDERS)

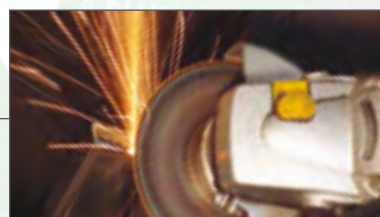

TYPE 27

42

COMBI SPEED

SPECIAL DEPRESSED CENTRE DISCS
FOR THIN CUTTING AND LIGHT GRINDING
(FOR PORTABLE ANGLE GRINDERS)



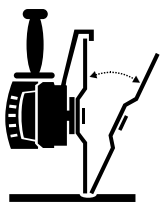

TYPE 27

CERAMICS AND CORUNDUM DEPRESSED CENTRE DISCS FOR CUTTING AND GRINDING WITH PORTABLE MACHINES



COMBI CERAMIC POWER

grinding wheels have been developed by GLOBE to be able to perform even better cutting, deburring and chamfering operations with a single product thanks to the special ceramic grits.



THE ADVANTAGES OF COMBI CERAMIC POWER

- Only one tool can be used for cutting and deburring
- No downtime for tool changes or interruption of work
- Very high cutting speed
- Excellent cutting quality and precision
- Very low formation of "burrs" during cutting
- Excellent stock removal capacity
- Excellent safety during deburring operations
- Maximum work efficiency
- Very long tool life

MATERIAL	DIMENSIONS (diam - thick - bore) mm	HARDNESS	USE SPEED	ARTICLE CODE		PLUS LINE
----------	--	----------	-----------	--------------	--	-----------

STAINLESS STEEL AND STEEL

SG 30-36 SX: COMBI CERAMIC POWER is an high-performance disc for cutting and grinding operations with a single product thanks to its ceramic grains. The compound free of iron compounds, sulphur and chlorine (certification available) makes the product suitable for use on stainless steel. Good cutting performance and durability.

DISC DURABILITY
CUTTING SPEED
CLEAN CUT
REMOVAL

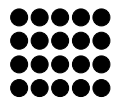

NEW	115x4,0x22,23	CERAMIC	SG 30-36 SX CER	80 m/s	G1063•	10pcs
NEW	125x4,0x22,23	CERAMIC	SG 30-36 SX CER	80 m/s	G1065•	10pcs
NEW	150x4,0x22,23	CERAMIC	SG 30-36 SX CER	80 m/s	G1066•	10pcs
NEW	180x4,0x22,23	CERAMIC	SG 30-36 SX CER	80 m/s	G1067•	10pcs
NEW	230x4,0x22,23	CERAMIC	SG 30-36 SX CER	80 m/s	G1068•	10pcs



Detail of ceramic grains under the microscope.



PATENTED

COMBI EXTRA

thanks to its 3,5/4,0mm thickness, it is suitable to perform harder cuts but favouring grinding jobs. Very appreciated as grinding wheel in all operations of light structural work instead of traditional (and heavier) 7,0mm thick wheels.

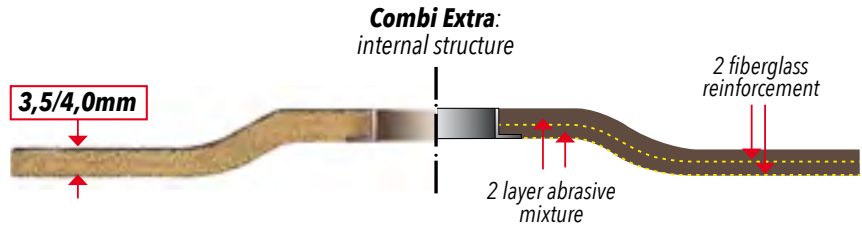

MATERIAL	DIMENSIONS (diam - thick. - bore) mm	HARDNESS	USE SPEED	ARTICLE CODE		PLUS LINE
----------	---	----------	-----------	--------------	--	-----------



A 30-36 R: for operations of cutting and light grinding with a single product. Suitable for iron and steel, good cutting capacity and long durability.

115x3,5x22,23	A 30-36 R	80 m/s	G1053 •	50pcs
125x3,5x22,23	A 30-36 R	80 m/s	G1055 •	50pcs
150x3,5x22,23	A 30-36 R	80 m/s	G1056 •	50pcs
180x4,0x22,23	A 30-36 R	80 m/s	G1057	50pcs
230x4,0x22,23	A 30-36 R	80 m/s	G1058 •	25pcs

DISC DURABILITY	●●●●○
CUTTING SPEED	●●●●○
CLEAN CUT	●●●●○
REMOVAL	●●●●○



A 30-36 RX: for operations of cutting and light grinding with a single product. The mixture free from iron, sulphur and chlorine (certification available), makes the product suitable to be used on stainless steel. Good cutting capacity and durability.

115x3,5x22,23	A 30-36 RX	80 m/s	G1043 •	50pcs
125x3,5x22,23	A 30-36 RX	80 m/s	G1045 •	50pcs
150x3,5x22,23	A 30-36 RX	80 m/s	G1046	50pcs
180x4,0x22,23	A 30-36 RX	80 m/s	G1151	50pcs
230x4,0x22,23	A 30-36 RX	80 m/s	G1154 •	25pcs

DISC DURABILITY	●●●●○
CUTTING SPEED	●●●●○
CLEAN CUT	●●●●○
REMOVAL	●●●●○

OTHER CUTTING/GRINDING DISCS

MATERIAL	DIMENSIONS (diam - thick. - bore) mm	HARDNESS	USE SPEED	ARTICLE CODE		PLUS LINE
----------	---	----------	-----------	--------------	--	-----------



A 30-36 Q: special combined grinding and cutting disc for standard applications, suitable for both cutting and grinding iron and steel. Good cutting and stock removal combined with good durability. Can also be used on stainless steel.

230x4,8x22,23	A 30-36 Q	80 m/s	6326039210100	25pcs
---------------	-----------	--------	---------------	-------

DISC DURABILITY	●●●●○
CUTTING SPEED	●●●●○
CLEAN CUT	●●●●○
REMOVAL	●●●●○



A 30-36 R: special combined grinding and cutting disc particularly suitable for machining iron and steel that combines good disc life with good stock removal and cutting capabilities.

230x4,8x22,23	A 30-36 R	80 m/s	6326039310100	25pcs
---------------	-----------	--------	---------------	-------

DISC DURABILITY	●●●●○
CUTTING SPEED	●●●●○
CLEAN CUT	●●●●○
REMOVAL	●●●●○



A 30-36 QX: special combined grinding and cutting disc for standard stainless steels. Good cutting capacity and grinding precision combined with good durability. Particularly suitable for light carpentry.

230x4,8x22,23	A 30-36 QX	80 m/s	6326039230100	25pcs
---------------	------------	--------	---------------	-------

DISC DURABILITY	●●●●○
CUTTING SPEED	●●●●○
CLEAN CUT	●●●●○
REMOVAL	●●●●○



Z 30-36 RG: special combined grinding and cutting disc with modified zirconium corundum. Particularly suitable for foundries of special and alloyed cast irons. Good cutting and grinding speed. Long service life. Good resistance to heavy-duty work such as chamfering of ridges and edges.

230x4,8x22,23	Z 30-36 RG	80 m/s	6326039120100	25pcs
---------------	------------	--------	---------------	-------

DISC DURABILITY	●●●●○
CUTTING SPEED	●●●●○
CLEAN CUT	●●●●○
REMOVAL	●●●●○

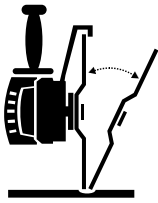

TYPE 27

DEPRESSED CENTER THIN DISCS FOR **CUTTING AND GRINDING** WITH PORTABLE GRINDERS

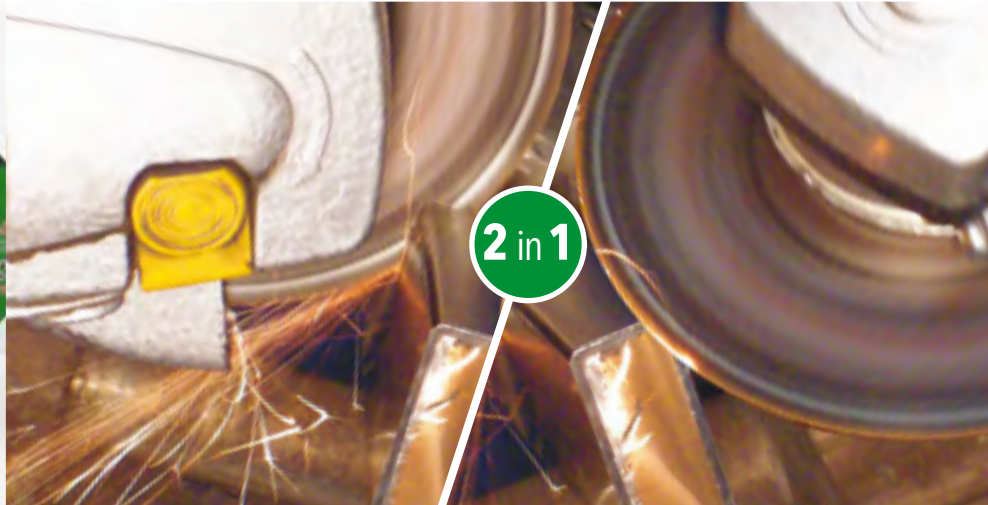

PATENTED

COMBI SPEED was especially conceived by GLOBE for cutting, light grinding and beveling with one single product. COMBI SPEED is the evolution of the COMBI wheel and thanks to the 2,0 mm thickness only and the 2-layer structure with 3 reinforcement cloths, it combines in a single disc an excellent cutting capacity and a high safety during grinding operations. Safety and resistance of COMBI SPEED are constantly internally tested by side-load tests and burst tests.



THE ADVANTAGES OF COMBI SPEED

- Possibility to use a single tool for both cutting and grinding
- No downtime or work interruption for replacing the tool
- High cutting speed
- Good quality and precision of cutting operation
- Low generation of burrs while cutting
- Good removal capacity
- Maximum safety during grinding operations
- Maximum work performance
- Long durability

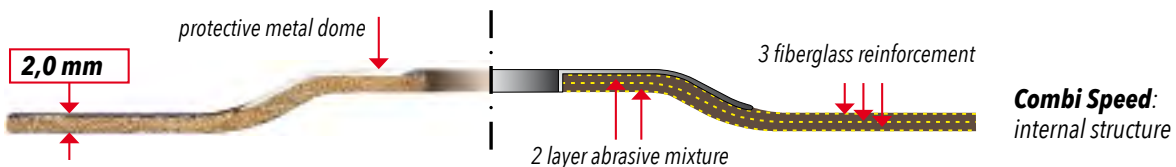

MATERIAL	DIMENSIONS (diam - thick. - bore) mm	HARDNESS	USE SPEED	ARTICLE CODE	
----------	---	----------	-----------	--------------	--

STAINLESS STEEL AND STEEL

A 60 SX: disc with 2 layers, especially designed with 2,0 mm thickness to obtain a product characterized by high cutting capacity (thanks to the low thickness) and high safety in light grinding operations. The wheel is free from iron, sulphur and chlorine compounds and thus suitable for stainless steel.

PLUS LINE

DISC DURABILITY	●●●●○
CUTTING SPEED	●●●●○
CLEAN CUT	●●●●○
REMOVAL	●●●●○

NEW	115x2,0x22,23	A 60 SX	80 m/s	G1039 •	50pcs
NEW	125x2,0x22,23	A 60 SX	80 m/s	G1041 •	50pcs
NEW	150x2,0x22,23	A 60 SX	80 m/s	G1042	50pcs

• = articles always in stock



TYPE 27

GRINDING WHEELS WITH DEPRESSED CENTER

(FOR PORTABLE ANGLE GRINDERS)
 SPECIAL GRINDING: CERAMIC POWER AND VIBLOCK
 HEAVY GRINDING: GRIND POWER
 STANDARD GRINDING

44
46
47



TYPE 1

GRINDING FLAT WHEELS

(FOR PORTABLE AXIAL GRINDERS)

49



FLEXCELLENCE
FLEXCELLENCE EXTRA



TYPE 29
TURBOTWISTER



TYPE 28
CONE

DEPRESSED CENTER WHEELS FOR FLAT GRINDING

FLEXCELLENCE: MORE THAN A FIBERDISC
FLEXCELLENCE EXTRA: WITH SPECIAL TRIANGULAR CERAMIC GRAIN
TURBOTWISTER "CERAMIC POWER" & TURBOTWISTER: SEMI-FLEXIBLE
CONE: CONICAL WHEEL

50
51
52
54



SHAFT-MOUNTED WHEELS

(FOR PORTABLE STRAIGHT GRINDERS)

55



GRINDING BENCH WHEELS

(FOR BENCH GRINDERS)

56



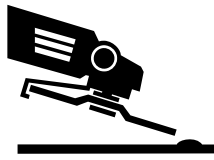

TYPE 27

CERAMIC GRINDING WHEELS CD FOR HEAVY GRINDING WITH PORTABLE ANGLE GRINDERS

GRINDING



THE NEW LINE OF CERAMIC GRINDING WHEELS.

The ceramic grain (of the best quality) differs from corundum and alumina zirconia for its very high grinding/cutting speed, as well as for its long durability. Another highly appreciated feature is the low workload required from the operator for grinding/cutting operations. This results in less effort, making operations more comfortable, increasing productivity. The particularly sharp ceramic grain give high abrasion, reduce friction of harmful rubbing (and heat generation) and maximize the grinding/cutting work with consequent reduction of pitting that otherwise would have to be removed with different products (e.g. flap discs). CERAMIC POWER GUARANTEES 360° SAVINGS IN TERMS OF: TIME, ELECTRICITY, LABOUR AND NUMBER OF DISCS USED.



Microscope detail of ceramic grain.

MATERIAL	DIMENSIONS (diam - spess - foro) mm	HARDNESS	USE SPEED	ARTICLE CODE	
----------	--	----------	-----------	--------------	--

PLUS LINE

STAINLESS STEEL AND STEEL

SG 24 SBF CER: the new and special CERAMIC POWER disc was specifically conceived for the removal of welding seams, heavy grinding, removal of residues, edge grinding, chamfering and grinding of steel (including stainless steel). The special new generation mixture, the special combination of ceramic grains and the regular wear of the disc allow to carry out in a very short time unparalleled and uniform removal with minimum heat development and without burns.

DISC DURABILITY
REMOVAL CAPACITY
REMOVAL ACCURACY

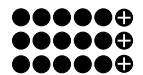

PATENTED

ALL THE ADVANTAGES OF GLOBE CERAMIC POWER (GRINDING)

- NEW CERAMIC GRAIN
- GREAT PRODUCTIVITY
- VERY HIGH REMOVAL CAPACITY
- GREATER PRECISION
- FASTER AND MORE PRECISE
- MORE OPERATOR COMFORT
- EASE OF USE
- LESS VIBRATIONS
- EXTREMELY LONG LIFETIME
- REDUCES ENERGY COSTS
- REDUCES LABOUR COSTS
- LESS PITTING

NEW	115x6,5x22,23	CERAMIC	SG 24 SBF CER	80 m/s	G0368•	10pcs
NEW	125x6,5x22,23	CERAMIC	SG 24 SBF CER	80 m/s	G0369•	10pcs
NEW	150x7,0x22,23	CERAMIC	SG 24 SBF CER	80 m/s	G0370•	10pcs
NEW	180x7,0x22,23	CERAMIC	SG 24 SBF CER	80 m/s	G0371•	10pcs
NEW	230x7,0x22,23	CERAMIC	SG 24 SBF CER	80 m/s	G0372•	10pcs

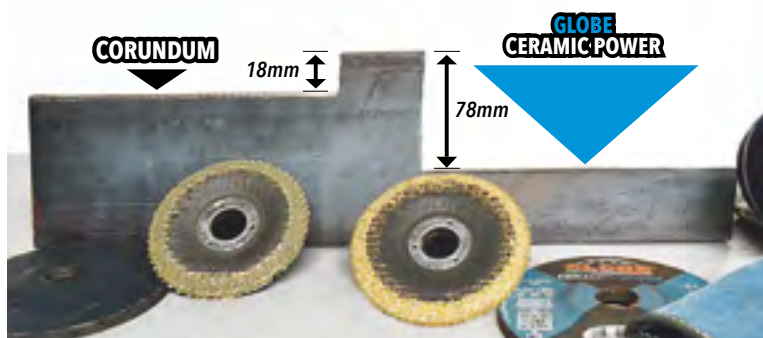

◀ LAB TEST (on 12mm mild steel plate) with a corundum disc (COMPETITOR) and GLOBE CERAMIC POWER. Discs used for the test: 125x6.5mm.

LAB TEST OF GRINDING ON BAR (MILD STEEL) 12mm AND 125x6,5mm DISC

SHORTER GRINDING TIME AND HIGHER REMOVAL RATE

Increased productivity and efficiency thanks to the special ceramic grain mixture, allowing a very high removal rate (+58% compared to corundum wheels). Unique on the market, drastically reduces working times.

GREAT DURABILITY AND GREATER SAVINGS

The special ceramic mixture conceived by GLOBE gives the disc an unprecedented durability, allowing to use less electricity and discs, with consequent economic and productivity benefits. All this, together with less waste, fewer stops for changing discs and more logistic advantages, make CERAMIC POWER an environmentally friendly abrasive product.

GREATER OPERATOR COMFORT AND MORE ACCURATE WORKINGS

The high removal capacity and short working times requires less pressure from the operator and makes work less hard, more productive and more economical. In addition, the regular edge wear allows more precise grinding and less stress for the grinder, extending its lifetime.

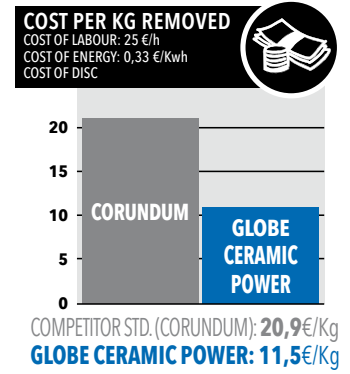
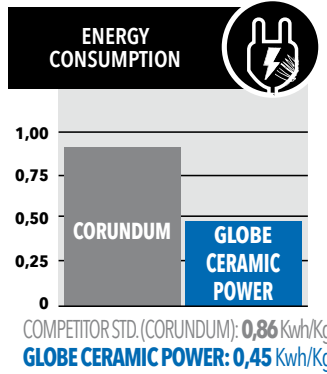
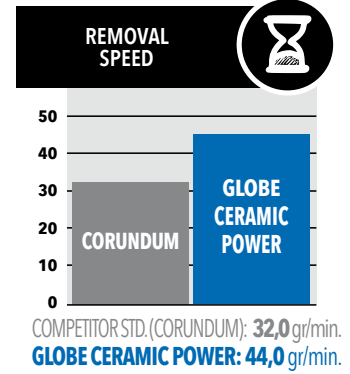
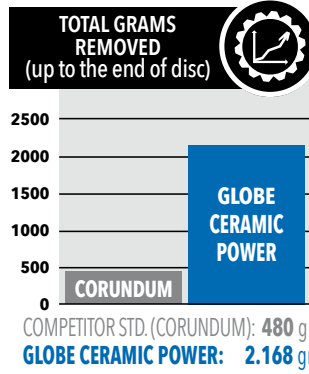

CERAMIC POWER in combination with the new set of damping flanges **VIBLOCK** (PATENTED), **VIBRATIONS ARE ALMOST NIL**, noise is reduced and user comfort becomes comparable to that of grinding with flap discs but offering much greater productivity and precision of work. In addition, the quality of grinding is very high with low surface roughness. The machine control is improved thanks to the very low vibrations, which regulates the contact between grinding wheel and workpiece, allowing works of excellent precision and finishing. All this also makes work easier for less experienced users who can carry out delicate grinding operations with greater ease.



3 ASSEMBLY STEPS:
VIBLOCK is simple to assemble.

OPERATION:
VIBLOCK improves performance and durability of the disc, reducing operator's fatigue.

	DESCRIPTION	ARTICLE CODE	
NEW	SET OF STEEL DAMPING FLANGES (BORE M14)	G3330 VIB LOCK	1pc
NEW	SET OF STEEL DAMPING FLANGES (BORE 5/8-11W)	G3330 VIB LOCK 5/8	1pc

VIBLOCK and GLOBE TYPE 27
VIBLOCK in combination with GLOBE Type 27 disc.
A winning couple to improve performance and effectiveness of your grinding.



METHOD OF USE

- Disconnect the power supply every time you install or disassemble a grinding wheel on the grinding machine.
- Use only with wheels manufactured by GLOBE: the profile of wheels made by other manufacturers may be different.
- Use only with depressed center grinding wheels. Do not use with flat wheels.
- The grinding wheel sliding against the rubberized support during tightening/disassembling could wear it out precociously; to avoid wear, keep the shaft of the grinding machine locked with the appropriate button and tighten/unscrew the front threaded flange with the appropriate wrench.

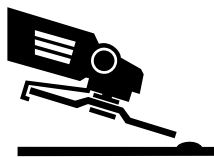

TYPE 27

DEPRESSED CENTER WHEELS FOR HEAVY GRINDING WITH PORTABLE ANGLE GRINDERS

GRINDING



GRIND POWER III

PATENTED



- ✓ LESS VIBRATIONS
- ✓ MORE COMFORT
- ✓ LESS EFFORT



GRIND POWER III is the most advanced and unequalled GLOBE technological solution for the professional grinding industry. The highly enriched alumina zirconia mixture of very high quality offers incomparable removal speed and durability, and can compete on equal terms even with the more expensive ceramic wheels. If used with grinders of suitable power (1400W for Ø 115 a125mm), GRIND POWER III is able to halve working times. The formula free from Fe, S, and Cl makes the product suitable also on stainless steel. The greatest innovation of GRIND POWER III stands in its **special anti-vibration insert** embedded in the wheel (patented technology that reduces vibrations transmitted to grinders and thus to users' hands and arms). In a world where attention to health and reduction of operators' exposure to fatigue, dangerous and damaging vibrations are increasingly important, GLOBE offers a practical tool to improve working conditions by rising up comfort of use to unprecedented levels. Thanks to GRIND POWER III, work becomes faster, more efficient, less tiring, less stressful and therefore more advantageous.

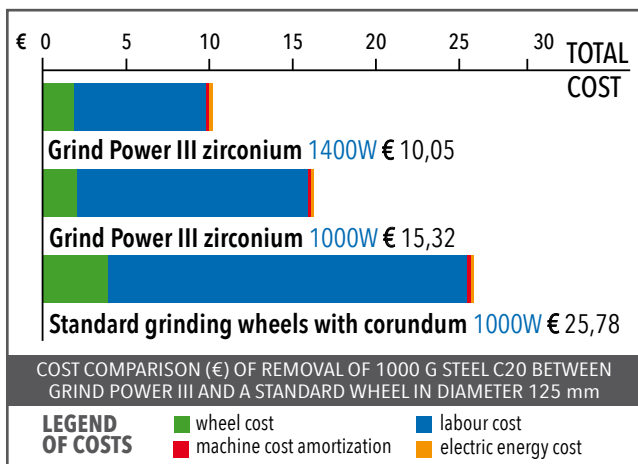

THE ADVANTAGES OF GRIND POWER III

- Very high removal capacity (at the level of ceramic grinding wheels) on all materials
- Reduction of working times (and costs)
- Increased productivity and efficiency
- Reduction of exposure to vibrations and noise
- Maximum comfort of use
- Less effort
- Free of Fe, S and Cl
- Can be used on many materials such as iron, steel, stainless steel, alloy steel, cast iron, special alloys, etc...

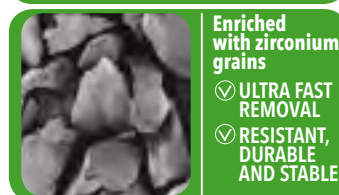

MATERIAL	DIMENSIONS (diam - thick. - bore) mm	HARDNESS	USE SPEED	ARTICLE CODE	
----------	--------------------------------------	----------	-----------	--------------	--

STAINLESS STEEL

ZA 24 SX (GRIND POWER II): grinding stainless steel. Great removal and long durability. Suitable for heavy works.

NEW	115x6,5x22,23 Grind Power II	ZA 24 SX	80 m/s	G0361 •	25pcs
NEW	125x7,0x22,23 Grind Power II	ZA 24 SX	80 m/s	G0362 •	25pcs
NEW	150x7,0x22,23 Grind Power II	ZA 24 SX	80 m/s	G0365 •	25pcs
NEW	180x7,0x22,23 Grind Power II	ZA 24 SX	80 m/s	G0366 •	25pcs
NEW	230x7,0x22,23 Grind Power II	ZA 24 SX	80 m/s	G0367 •	25pcs

DISC DURABILITY
REMOVAL CAPACITY
REMOVAL ACCURACY

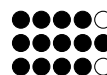

STAINLESS STEEL

ZA 24 SX (GRIND POWER III): grinding stainless steel. Great removal and long durability. Suitable for heavy works. Excellent comfort of use.

NEW	115x6,5x22,23 Grind Power III	ZA 24 SX	80 m/s	G0361-III	25pcs
NEW	125x7,0x22,23 Grind Power III	ZA 24 SX	80 m/s	G0362-III	25pcs
NEW	150x7,0x22,23 Grind Power III	ZA 24 SX	80 m/s	G0365-III	25pcs
NEW	180x7,0x22,23 Grind Power III	ZA 24 SX	80 m/s	G0366-III	25pcs
NEW	230x7,0x22,23 Grind Power III	ZA 24 SX	80 m/s	G0367-III	25pcs

DISC DURABILITY
REMOVAL CAPACITY
REMOVAL ACCURACY

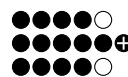

• = articles always in stock

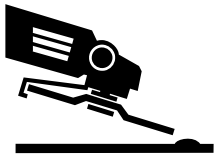

TYPE 27

DEPRESSED CENTER GRINDING WHEELS FOR PORTABLE ANGLE GRINDERS



GRINDING

The wide range of GLOBE grinding wheels offers different levels of hardness and different removal rates in order to provide the operator with the possibility to choose the most suitable type for the work to be carried out. GLOBE wheels are designed respecting strict limits of unbalancing in order to guarantee minimum vibrations during use. The quality characteristics of GLOBE wheels enhance economic efficiency of use in every context, as demonstrated by control and comparative tests carried out in the company laboratories. All the wheels designed for stainless steel have contents of iron, sulphur, and chlorine compounds lower than 0.1%, as shown on the label (certification available). GLOBE offers a large number of different specifications for the materials to be worked. The choice of the right type is fundamental to obtain maximum performance.

MATERIAL	DIMENSIONS (diam - thick. - bore) mm	HARDNESS	USE SPEED	ARTICLE CODE		PLUS LINE
STAINLESS STEEL AND STEEL	A 24-30-36 Q: grinding of iron and steel, good removal and medium durability. Medium-hard grinding wheel, especially suitable for not very heavy-duty works. Good comfort of use. It can also be used on stainless steel.					DISC DURABILITY REMOVAL CAPACITY REMOVAL ACCURACY
	100x6,0x16,00	A 24-30-36 Q	80 m/s	G0111	25pcs	
	115x6,5x22,23	A 24-30-36 Q	80 m/s	G0112 •	25pcs	
	125x6,5x22,23	A 24-30-36 Q	80 m/s	G0113 •	25pcs	
	150x7,0x22,23	A 24-30-36 Q	80 m/s	G0114 •	25pcs	
	180x7,0x22,23	A 24-30-36 Q	80 m/s	G0115 •	25pcs	
	180x8,5x22,23	A 24-30-36 Q	80 m/s	5325155010100	25pcs	
	230x7,0x22,23	A 24-30-36 Q	80 m/s	G0117 •	25pcs	
230x8,0x22,23	A 24-30-36 Q	80 m/s	G0118	25pcs		
STEEL	A 24-30-36 R: excellent removal rate and long durability. Suitable for heavy-duty works such as grinding of jagged fins, sharp edges and welding of ferrous metal.					DISC DURABILITY REMOVAL CAPACITY REMOVAL ACCURACY
	115x6,5x22,23	A 24-30-36 R	80 m/s	G0122 •	25pcs	
	125x6,5x22,23	A 24-30-36 R	80 m/s	G0123 •	25pcs	
	150x7,0x22,23	A 24-30-36 R	80 m/s	G0124 •	25pcs	
	180x7,0x22,23	A 24-30-36 R	80 m/s	G0125 •	25pcs	
	180x8,5x22,23	A 24-30-36 R	80 m/s	5325155110100	25pcs	
	230x7,0x22,23	A 24-30-36 R	80 m/s	G0127 •	25pcs	
	230x8,0x22,23	A 24-30-36 R	80 m/s	G0128	25pcs	
STEEL	Z 24-30-36 S: grinding wheel containing alumina zirconia. Particularly suitable for heavy-duty works. High removal rate and long life. Suitable for high frequency grinders for special heavy structural works.					DISC DURABILITY REMOVAL CAPACITY REMOVAL ACCURACY
	180x8,0x22,23	Z 24-30-36 S	80 m/s	G0136	25pcs	
	230x8,0x22,23	Z 24-30-36 S	80 m/s	5326054140100	25pcs	
CAST IRON	A 24-30-36 OG: medium-soft wheel for standard cast iron. Recommended for grinding dirty castings where high removal is required to avoid that the wheel gets clogged.					DISC DURABILITY REMOVAL CAPACITY REMOVAL ACCURACY
	180x7,0x22,23	A 24-30-36 OG	80 m/s	G0211	25pcs	
	230x7,0x22,23	A 24-30-36 OG	80 m/s	G0213	25pcs	

MATERIAL	DIMENSIONS (diam - thick. - bore) mm	HARDNESS	USE SPEED	ARTICLE CODE	
----------	---	----------	--------------	-----------------	---

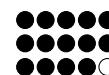
PLUS LINE    **CAST IRON****Z 24-30-36 RG:** medium-hard grinding wheel for foundry applications. High removal and long durability.DISC DURABILITY
REMOVAL CAPACITY
REMOVAL ACCURACY

125x6,5x22,23	Z 24-30-36 RG	80 m/s	5324248180100	50pcs
180x8,0x22,23	Z 24-30-36 RG	80 m/s	G0222	25pcs
230x8,0x22,23	Z 24-30-36 RG	80 m/s	G0224	25pcs

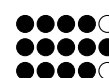
 **ALUMINIUM****A 24-30-36 QAL:** grinding of aluminium and other non-ferrous materials (copper, brass ...). The abrasive mixture used, especially lubricating, allows to obtain high removal rates without clogging.DISC DURABILITY
REMOVAL CAPACITY
REMOVAL ACCURACY

115x6,5x22,23	A 24-30-36 QAL	80 m/s	G0411 •	25pcs
125x6,5x22,23	A 24-30-36 QAL	80 m/s	G0412 •	25pcs
150x7,0x22,23	A 24-30-36 QAL	80 m/s	G0413	25pcs
180x7,0x22,23	A 24-30-36 QAL	80 m/s	G0414	25pcs
230x7,0x22,23	A 24-30-36 QAL	80 m/s	G0415 •	25pcs

 **STONE****C 24-30-36 QE:** applications in the building industry for grinding stones, marble, terracotta, concrete and other special materials. High cutting capacity, medium durability.DISC DURABILITY
REMOVAL CAPACITY
REMOVAL ACCURACY

100x6,0x16,00	C 24-30-36 QE	80 m/s	G0511	25pcs
115x6,5x22,23	C 24-30-36 QE	80 m/s	G0512	25pcs
125x6,5x22,23	C 24-30-36 QE	80 m/s	G0513	25pcs
150x7,0x22,23	C 24-30-36 QE	80 m/s	G0514	25pcs
180x7,0x22,23	C 24-30-36 QE	80 m/s	G0515	25pcs
230x7,0x22,23	C 24-30-36 QE	80 m/s	G0516 •	25pcs

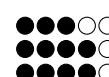
 **STAINLESS
STEEL****A 24-30-36 QX:** medium hardness and good removal rate. Ideal also for standard and hard stainless steel castings.DISC DURABILITY
REMOVAL CAPACITY
REMOVAL ACCURACY

115x6,5x22,23	A 24-30-36 QX	80 m/s	G0311 •	25pcs
125x6,5x22,23	A 24-30-36 QX	80 m/s	G0312 •	25pcs
150x7,0x22,23	A 24-30-36 QX	80 m/s	G0313	25pcs
180x7,0x22,23	A 24-30-36 QX	80 m/s	G0314	25pcs
230x7,0x22,23	A 24-30-36 QX	80 m/s	G0315 •	25pcs

 **STAINLESS
STEEL****A 24-30-36 RX:** excellent removal rate and good resistance. Also suitable for food processing applications.DISC DURABILITY
REMOVAL CAPACITY
REMOVAL ACCURACY

115x6,5x22,23	A 24-30-36 RX	80 m/s	G0321 •	25pcs
125x6,5x22,23	A 24-30-36 RX	80 m/s	G0322 •	25pcs
180x7,0x22,23	A 24-30-36 RX	80 m/s	G0324	25pcs
230x7,0x22,23	A 24-30-36 RX	80 m/s	G0325 •	25pcs

 **STAINLESS
STEEL****Z 24-30-36 SX:** wheel containing alumina zirconia, suitable for very heavy-duty works in heavy structural works. High removal rate and long durability. Suitable for high frequency grinders.DISC DURABILITY
REMOVAL CAPACITY
REMOVAL ACCURACY

180x8,0x22,23	Z 24-30-36 SX	80 m/s	G0334	25pcs
230x8,0x22,23	Z 24-30-36 SX	80 m/s	5326051201100	25pcs

 **STAINLESS
STEEL****Z 24-30-36 QX:** wheel containing alumina zirconia, suitable for very heavy-duty works in heavy structural works. High removal rate and long durability. To be used with high frequency grinders.DISC DURABILITY
REMOVAL CAPACITY
REMOVAL ACCURACY

230x7,0x22,23	Z 24-30-36 QX	80 m/s	G0315 HF	25pcs
---------------	---------------	--------	----------	-------

MATERIAL	DIMENSIONS (diam - thick. - bore) mm	HARDNESS	USE SPEED	ARTICLE CODE	
----------	---	----------	--------------	-----------------	--

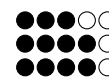
DYNAMIC LINE  **STAINLESS
STEEL AND
STEEL****A 24-30-36 R:** good removal rate and long durability. Suitable for grinding of jagged fins, sharp edges and welding of ferrous metals.DISC DURABILITY
REMOVAL CAPACITY
REMOVAL ACCURACY

NEW	115x6,0x 22,23	A 24-30-36 R	80 m/s	G0122 DYN •	25pcs
NEW	125x6,0x22,23	A 24-30-36 R	80 m/s	G0123 DYN •	25pcs
NEW	180x6,5x22,23	A 24-30-36 R	80 m/s	G0324 DYN •	25pcs
NEW	230x6,5x22,23	A 24-30-36 R	80 m/s	G0325 DYN •	25pcs

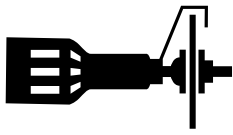

TYPE 1

FLAT WHEELS FOR FRONT GRINDING WITH PORTABLE AXIAL GRINDERS



GRINDING

These wheels are used on portable straight grinders for internal grinding of workpieces, such as internal lapping of pipes in the petrochemical industry. Great care is taken in balancing these wheels to prevent vibrations and to ensure maximum control by the operator. These wheels are manufactured with specifications for use at 45 m/s (without reinforcements) and for use at 63 and 80 m/s (reinforced). Thanks to the special mixture, a high removal rate is achieved without overheating the workpiece.



G1825
100x20,0x20,00
Type 1
Thickness:
20,0mm.

MATERIAL	DIMENSIONS (diam - thick. - bore) mm	HARDNESS	USE SPEED	ARTICLE CODE		PLUS LINE	
STEEL	A 30-36 R: suitable for steel. Offers a good removal capacity and long durability. Excellence resistance to stress.					DISC DURABILITY	●●●●○
	50x4,0x9,53	A 30-36 R	80 m/s	G1831 9,5	100pcs	REMOVAL CAPACITY	●●●●○
	75x4,0x9,53	A 30-36 R	80 m/s	G1832 9,5	100pcs	REMOVAL ACCURACY	●●●●○
STAINLESS STEEL	A 30-36 QX: for standard stainless steel. Good removal capacity and medium durability. Especially suitable for light structural works.					DISC DURABILITY	●●●●○
	50x4,0x9,53	A 30-36 QX	80 m/s	G1811 9,5	100pcs	REMOVAL CAPACITY	●●●●○
	75x4,0x9,53	A 30-36 QX	80 m/s	G1812 9,5 •	100pcs	REMOVAL ACCURACY	●●●●○
STAINLESS STEEL AND STEEL	A 30 36 Q: standard uses, suitable for iron and steel. Good removal rate and medium durability. It can also be used on stainless steel.					DISC DURABILITY	●●●●○
	100x20,0x20,00	A 30 36 Q	45 m/s	G1825	50pcs	REMOVAL CAPACITY	●●●●○
	100x20,0x20,00	A 30 36 Q	80 m/s	G1825 80	50pcs	REMOVAL ACCURACY	●●●●○
STAINLESS STEEL	A 30 36 QX: for use on alloy steel and stainless steel (free from iron, sulphur and chlorine compounds). High removal rate and medium hardness.					DISC DURABILITY	●●●●○
	50x12,0x8,00	A 30 36 QX	45 m/s	9010501280100	100pcs	REMOVAL CAPACITY	●●●●○
	75x8,0x8,00	A 30 36 QX	80 m/s	7082154310101	100pcs	REMOVAL ACCURACY	●●●●○
	100x20,0x20,00	A 30 36 QX	45 m/s	G1815 •	50pcs		●●●●○
	100x20,0x20,00	A 30 36 QX	63 m/s	9000005045700 •	50pcs		●●●●○
	100x20,0x20,00	A 30 36 QX	80 m/s	G1815 80	50pcs		●●●●○
STAINLESS STEEL	A 60 QX: for use on alloy steel and stainless steel.					DISC DURABILITY	●●●●○
	100x20,0x20,00	A 60 QX	63 m/s	9000005045400	50pcs	REMOVAL CAPACITY	●●●●○
STAINLESS STEEL	A 30 36 RX: for use on alloy steel and stainless steel. Higher hardness than A60QX.					DISC DURABILITY	●●●●○
	100x20,0x20,00	A 30 36 RX	63 m/s	G1820 60	50pcs	REMOVAL CAPACITY	●●●●○
	125x25,0x20,00	A 30 36 RX	63 m/s	G1840 60	50pcs	REMOVAL ACCURACY	●●●●○

• = articles always in stock



DEPRESSED CENTER FLEXIBLE WHEELS FOR PRECISION GRINDING WITH PORTABLE ANGLE GRINDERS



FLEXCELLENCE is the innovative semiflexible depressed center fiberdisc with built-in backing pad designed by GLOBE for a more **PRECISE**, **FASTER** and **COMFORTABLE**.

PRECISION: the calibrated flexibility of FLEXCELLENCE allows extremely precise works compared to standard grinding wheels and allows to work exactly where needed, without affecting the surrounding areas.

SPEED: the formulation of ceramic abrasive grains and special cooling fillers allow an extremely quick material removal without overheating and pitting of the workpiece.

EASY ASSEMBLY: thanks to the built-in support which eliminates the inconvenience of the traditional backing pad, FLEXCELLENCE is quickly installed like a standard grinding wheel or flap disc.

COMFORT: FLEXCELLENCE is best used with an angle of 10-15° and with its special installation kit, while the special internal shock-absorbing element reduces vibrations and noise and makes the work less tiring.

MATERIAL	DIMENSIONS (diam - bore) mm	HARDNESS	USE SPEED	ARTICLE CODE	
----------	--------------------------------	----------	--------------	-----------------	--

PLUS LINE

DISC DURABILITY
REMOVAL CAPACITY
REMOVAL ACCURACY

STAINLESS STEEL AND STEEL

SG: suitable for iron, steel, and stainless steel: Fe, Cr, S < 0.1%.

NEW	115x22,23	Flexcellence	SG 36	80 m/s	G3333 •	25pcs
NEW	115x22,23	Flexcellence	SG 60	80 m/s	G3336 •	25pcs
NEW	115x22,23	Flexcellence	SG 80	80 m/s	G3337 •	25pcs
NEW	115x22,23	Flexcellence	SG 120	80 m/s	G3339 •	25pcs
NEW	125x22,23	Flexcellence	SG 36	80 m/s	G3353 •	25pcs
NEW	125x22,23	Flexcellence	SG 60	80 m/s	G3356 •	25pcs
NEW	125x22,23	Flexcellence	SG 80	80 m/s	G3357 •	25pcs
NEW	125x22,23	Flexcellence	SG 120	80 m/s	G3359 •	25pcs
NEW	180x22,23	Flexcellence	SG 36	80 m/s	G3373 •	25pcs
NEW	180x22,23	Flexcellence	SG 60	80 m/s	G3374 •	25pcs
NEW	180x22,23	Flexcellence	SG 80	80 m/s	G3375 •	25pcs

THE ADVANTAGES OF FLEXCELLENCE

- Working precision •
- Reduction of working times •
- Quick and easy assembly •
- Time and energy saving •
- Less vibration and less noise •
- Greater comfort of use •

ALUMINIUM

QAL: specific for working on aluminium, it does not clog, does not knead, fast removal.

NEW	115x22,23	Flexcellence	SG 36 QAL	80 m/s	G3343	25pcs
NEW	125x22,23	Flexcellence	SG 36 QAL	80 m/s	G3363	25pcs

DISC DURABILITY
REMOVAL CAPACITY
REMOVAL ACCURACY

1) Angle 10/15°

2) Quick assembly

3) Smoothing sharp edges

4) Grinding of convex surfaces

5) Grinding of concave surfaces

6) Removal of imperfections

7) Perfect smoothing of welds

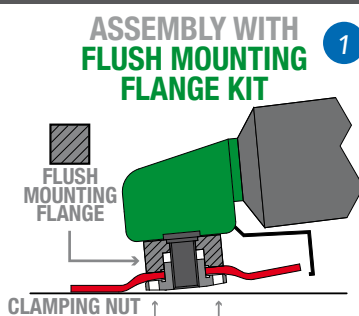



VERY GOOD
ABRASIVE CAPACITY



LOW
VIBRATIONS



REDUCTION
OF WORKING TIMES



COST
REDUCTIONS



PRECISE FLATTENING
OF WELDS



LOW
NOISE



FLEXCELLENCE
EXTRA

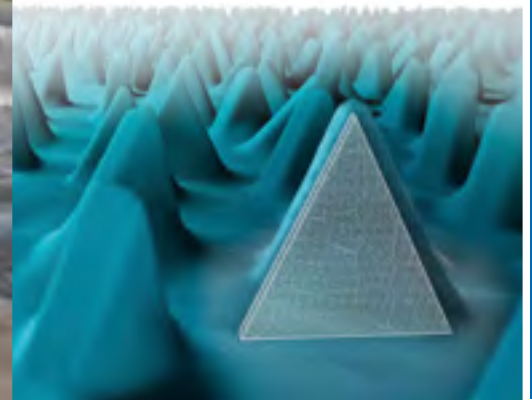

GRINDING

FLEXCELLENCE EXTRA is the innovative semi-flexible depressed center ceramic fiberdisc with special triangular ceramic grain and integrated backing pad, designed by GLOBE, to obtain a more **PRECISE, FASTER** and **COMFORTABLE** grinding of:

- **WELDING SEAMS**
- **SHARP EDGES**
- **FLAT, CONVEX AND CONCAVE SURFACES**
- **IMPERFECTIONS**

SPECIAL TRIANGULAR CERAMIC GRAIN

This particular shape allows to obtain the maximum removal of material, fast and a very long life, without overheating the workpiece..



Assembly of **FLEXCELLENCE** and **FLEXCELLENCE EXTRA** with plastic **SPACER** supplied.



Assembly of **FLEXCELLENCE** and **FLEXCELLENCE EXTRA** with special **SET** of **STEEL FLANGES**.

THE FURTHER ADVANTAGES OF FLEXCELLENCE EXTRA

+30% PERFORMANCE
SPECIAL TRIANGULAR CERAMIC GRAIN
IT WORKS EXACTLY WHERE YOU WANT

GREAT STOCK REMOVAL
NO DUST
LONGER DURABILITY
EASY AND FAST MOUNTING

To get the best from **FLEXCELLENCE** and **FLEXCELLENCE EXTRA**, every package contains a thick flange (**SPACER**) specifically designed to position the wheel closer to the grinder safety guard profile allowing also flat grinding. For even more professional users GLOBE supplies a special **STEEL FLANGE SET** that fits to all the grinders existing on the market and optimize the disc positioning.

MATERIAL	DIMENSIONS (diam - bore) mm	HARDNESS	USE SPEED	ARTICLE CODE	
----------	-----------------------------	----------	-----------	--------------	--

PLUS LINE

STAINLESS STEEL AND STEEL

SG: suitable for iron, steel, and stainless steel: Fe, Cl, S <0.1%.

DISC DURABILITY

REMOVAL CAPACITY

REMOVAL ACCURACY

NEW	115x22,23	Flexcellence Extra	SG 36	80 m/s	G3333 EXTRA•	25pcs
NEW	125x22,23	Flexcellence Extra	SG 36	80 m/s	G3353 EXTRA •	25pcs



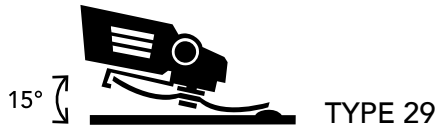

SEMI-FLEXIBLE GRINDING WHEELS WITH PORTABLE ANGLE GRINDERS



TURBOTWISTER and TURBOTWISTER CERAMIC-POWER

are the semi-flexible wheel characterized by a working surface with rhomboidal grooves that increase removal rate and create a cooling effect thanks to air circulation through the grooves. The specification for metal, free from iron, sulphur and chlorine compounds, is also suitable for stainless steel. The large contact area guarantees an excellent planarity of the surface treated.

LAB TEST (10 MINUTES) ON 12mm MILD STEEL C20 BAR

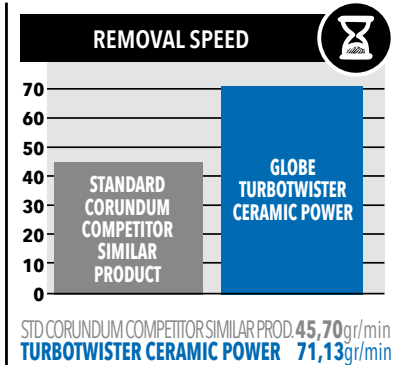
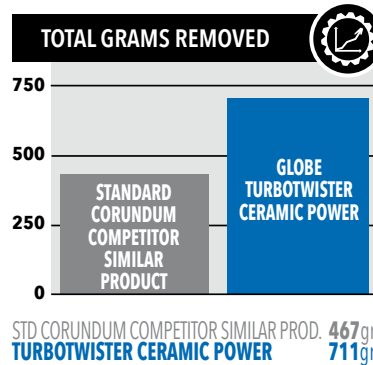

THE SPECIAL THICK BACK FLANGES DESIGNED BY GLOBE

They allow (in the respect of all the safety regulations) a more comfortable and precise grinding work, besides improving the disc performance.



The 2 different SPACERS by GLOBE.



Flush mounting with the special GLOBE flanges.



The special surface covered by raised grooves, guarantees greater power on all metals.

The spiral grooves of the grinding surface create a very effective air circulation which cools metal and prevents overheating. The 3 mm deep pyramidal grooves give high and constant removal speed on all materials.

APPLICATIONS OF TURBOTWISTER

- Fast removal of welding burrs
- Grinding of flat, concave and convex surfaces
- Finishing of castings of any shape
- Grinding of stainless steel without overheating
- Works where a standard abrasive wheel would cause deep incisions
- Removal of welding drops and joints without damaging the surrounding metal

THE ADVANTAGES OF TURBOTWISTER

- Two operations (grinding and finishing) in a single pass
- Flexibility
- Fast removal
- Excellent finishing
- More comfort
- Less noise

MATERIAL	DIMENSIONS (diam - thick. - bore) mm	HARDNESS	USE SPEED	ARTICLE CODE	
----------	---	----------	--------------	-----------------	---

PLUS LINE   

 **STAINLESS
STEEL AND
STEEL** **NEW**
NEW
NEW
NEW

SG 36 SBF CER: the new TurboTwister CERAMIC POWER is designed to increase the uniqueness and ductility of TurboTwister.

115x22,23	Turbotwister CER	SG 36 SBF CER	80 m/s	G0826	25pcs
125x22,23	Turbotwister CER	SG 36 SBF CER	80 m/s	G0827	25pcs
150x22,23	Turbotwister CER	SG 36 SBF CER	80 m/s	G0828	25pcs
180x22,23	Turbotwister CER	SG 36 SBF CER	80 m/s	G0829	25pcs



HIGH REMOVAL
CAPACITY



LESS VIBRATIONS
MORE COMFORT



LOWER
OVERHEATING



REDUCED COSTS



ACCURATE GRINDING
OF WELDS



LESS NOISE

 **STAINLESS
STEEL AND
STEEL**

A 24 Q: perfect for ferrous and non-ferrous metal working and where a high removal rate is needed, without clogging of the wheel.

115x22,23	Turbotwister HP	A 24 Q	80 m/s	G0811	25pcs
125x22,23	Turbotwister HP	A 24 Q	80 m/s	G0812	25pcs
150x22,23	Turbotwister HP	A 24 Q	80 m/s	G0813	25pcs
180x22,23	Turbotwister HP	A 24 Q	80 m/s	G0814	25pcs

 **STAINLESS
STEEL AND
STEEL**

A 36 Q: for grinding steel and stainless steel. Excellent removal rate, medium degree of finishing and excellent durability.

75x9,53	Turbotwister HP	A 36 Q	80 m/s	G0825	100pcs
115x22,23	Turbotwister HP	A 36 Q	80 m/s	G0821 •	25pcs
125x22,23	Turbotwister HP	A 36 Q	80 m/s	G0822 •	25pcs
150x22,23	Turbotwister HP	A 36 Q	80 m/s	G0823	25pcs
180x22,23	Turbotwister HP	A 36 Q	80 m/s	G0824 •	25pcs

 **STAINLESS
STEEL AND
STEEL**

A 60 Q: good degree of finishing and medium removal rate.

75x9,53	Turbotwister HP	A 60 Q	80 m/s	G0835	100pcs
115x22,23	Turbotwister HP	A 60 Q	80 m/s	G0831 •	25pcs
125x22,23	Turbotwister HP	A 60 Q	80 m/s	G0832 •	25pcs
150x22,23	Turbotwister HP	A 60 Q	80 m/s	G0833	25pcs
180x22,23	Turbotwister HP	A 60 Q	80 m/s	G0834 •	25pcs

 **STAINLESS
STEEL AND
STEEL**

A 100 Q: excellent degree of finishing and moderate removal rate. Long durability, ideal for all types of steel.

115x22,23	Turbotwister HP	A 100 Q	80 m/s	G0841	25pcs
125x22,23	Turbotwister HP	A 100 Q	80 m/s	G0842	25pcs
150x22,23	Turbotwister HP	A 100 Q	80 m/s	G0843	25pcs
180x22,23	Turbotwister HP	A 100 Q	80 m/s	G0844	25pcs

 **ALUMINIUM**

A 36 QAL: grinding of aluminium and other soft non-ferrous metals (copper, brass...). The abrasive mixture used, especially lubricated, allows high removal rates throughout the whole life of the wheel without clogging.

115x22,23	Turbotwister HP	A 36 QAL	80 m/s	G0871 •	25pcs
125x22,23	Turbotwister HP	A 36 QAL	80 m/s	G0872 •	25pcs
180x22,23	Turbotwister HP	A 36 QAL	80 m/s	G0874 •	25pcs

 **STONE**

C 24 Q: especially suitable for working clogging material (such as fiber-glass). High removal rate and medium durability.

115x22,23	Turbotwister HP	C 24 Q	80 m/s	G0911	25pcs
125x22,23	Turbotwister HP	C 24 Q	80 m/s	G0912	25pcs
150x22,23	Turbotwister HP	C 24 Q	80 m/s	G0913	25pcs
180x22,23	Turbotwister HP	C 24 Q	80 m/s	G0914	25pcs

 **STONE**

C 36 Q: especially suitable for the building industry to grind stone, marble, terracotta, concrete, etc. High removal rate and good durability.

115x22,23	Turbotwister HP	C 36 Q	80 m/s	G0921	25pcs
125x22,23	Turbotwister HP	C 36 Q	80 m/s	G0922	25pcs
150x22,23	Turbotwister HP	C 36 Q	80 m/s	G0923	25pcs
180x22,23	Turbotwister HP	C 36 Q	80 m/s	G0924	25pcs

Also available, upon request, in C 60 Q e C 100 Q grits.



Turbotwister discs are particularly suitable for precise grinding operations on concave, convex surfaces, edges, welding dropps, joints, burrs...



For the building industry, concrete, granite, marble, natural and artificial stones.

GRINDING

• = articles always in stock

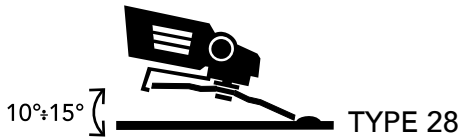

CONICAL WHEELS FOR FLAT GRINDING WITH PORTABLE ANGLE GRINDERS



Grinding of weld beads on leveled surfaces requires working in a horizontal position. With standard "Type 27" depressed center wheels, performance is not the best as you are forced to work with an angle of at least 15° to the work surface. On the other hand, with "Type 28" **CONE** grinding wheels, it is possible to work in horizontal position, as they are built with a natural angle of 15° allowing flat grinding also in standard grinding operations. The contact area of conical grinding wheels is much wider than that obtained with a standard "Type 27" grinding wheel and this results in a perfect planarity.

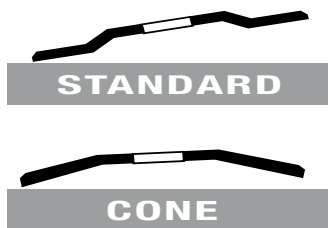

STANDARD

CONE

Difference of the angle used between a standard depressed center wheel and a CONE wheel.

THE ADVANTAGES OF CONE

- Possibility to use the grinder in horizontal position
- More comfort for users
- Perfect planarity of the grinded surface
- High performance
- Long durability
- Available for steel, stainless steel and for cast iron on demand



MATERIAL	DIMENSIONS (diam. - thick. - bore) mm	HARDNESS	USE SPEED	ARTICLE CODE		PLUS LINE	
STAINLESS STEEL AND STEEL	A 24-30-36 Q: grinding of iron and steel, for standard applications. Medium hardness, good removal rate, medium durability. Suitable for not too heavy duty works. Comfort of use. It can also be used on stainless steel.					DISC DURABILITY REMOVAL CAPACITY REMOVAL ACCURACY	
	115x6,5x22,23	CONE	A 24-30-36 Q	80 m/s	G0641 •	25pcs	●●●●○
	125x6,5x22,23	CONE	A 24-30-36 Q	80 m/s	G0651 •	25pcs	●●●●○
	180x8,0x22,23	CONE	A 24-30-36 Q	80 m/s	G0711	25pcs	●●●●○
	230x8,0x22,23	CONE	A 24-30-36 Q	80 m/s	G0712 •	25pcs	●●●●○
STEEL	A 24-30-36 R: high removal rate and long durability. Ideal for heavy duty works such as grinding of weldings, jagged fins and sharp edges.					DISC DURABILITY REMOVAL CAPACITY REMOVAL ACCURACY	
	115x6,5x22,23	CONE	A 24-30-36 R	80 m/s	G0643	25pcs	●●●●○
	125x6,5x22,23	CONE	A 24-30-36 R	80 m/s	G0653	25pcs	●●●●○
	180x8,0x22,23	CONE	A 24-30-36 R	80 m/s	G0721	25pcs	●●●●○
	230x8,0x22,23	CONE	A 24-30-36 R	80 m/s	G0722	25pcs	●●●●○
STEEL	Z 24-30-36 S (ON DEMAND) wheel containing alumina zirconia, suitable for extremely heavy duty works. High removal rate and long durability, for use with high frequency grinders in heavy structural work.						
CAST IRON	Z 24-30-36 RG: (ON DEMAND) wheel containing alumina zirconia, high removal rate and long durability. Especially suitable for grinding hard cast iron, jagged fins and sharp edges.						



CERAMIC BONDED SHAFT-MOUNTED WHEELS FOR PORTABLE STRAIGHT GRINDERS

GRINDING

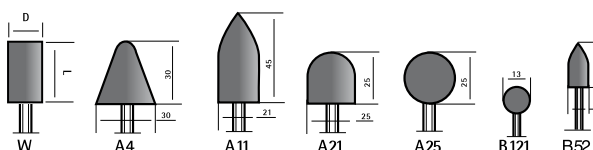

MATERIAL	SHAPE	DIMENSIONS (Diam. - Length - Ø shaft) mm	HARDNESS	ARTICLE CODE	
----------	-------	---	----------	-----------------	--

**STAINLESS
STEEL AND
STEEL**

W	10x30x6	30 Q	G3711-INOX	100pcs
W	15x20x6	30 Q	G3721-INOX	100pcs
W	20x20x6	30 Q	G3731-INOX	100pcs
W	20x25x6	30 Q	G3741-INOX	100pcs
W	20x30x6	30 Q	G3751-INOX	100pcs
W	25x25x6	30 Q	G3761-INOX	100pcs
W	30x10x6	30 Q	G3811-INOX	100pcs
W	30x20x6	30 Q	G3821-INOX	100pcs
W	30x30x6	30 Q	G3831-INOX	100pcs
W	40x20x6	30 Q	9030400206061	100pcs
W	40x30x6	30 Q	G3851-INOX	100pcs

A4	30x30x6	30 Q	G3911-INOX	100pcs
A11	21x45x6	30 Q	G3921-INOX	100pcs
A21	25x25x6	30 Q	G3931-INOX	100pcs
B52	10x20x6	60 Q	G3961-INOX	100pcs

STEEL

W	10x30x6	60 P	G3711 •	100pcs
W	15x20x6	60 P	G3721 •	100pcs
W	20x20x6	46 P	G3731 •	100pcs
W	20x25x6	46 P	G3741 •	100pcs
W	20x30x6	46 P	G3751 •	100pcs
W	25x25x6	46 P	G3761 •	100pcs
W	30x10x6	46 P	G3811 •	100pcs
W	30x20x6	46 P	G3821 •	100pcs
W	30x30x6	46 P	G3831 •	100pcs
W	35x35x6	46 P	G3841 •	100pcs
W	40x20x6	46 P	9030400206060	100pcs
W	40x30x6	46 P	G3851 •	100pcs
W	40x40x6	46 P	G3861 •	100pcs

A4	30x30x6	46 P	G3911 •	100pcs
A11	21x45x6	46 P	G3921 •	100pcs
A21	25x25x6	46 P	G3931 •	100pcs
A25	25x25x6	46 P	G3941 •	100pcs
B121	13x13x6	46 P	G3951 •	100pcs
B52	10x10x6	60 P	G3961 •	100pcs

CAST IRON

W	40x20x6	24-30 Q	9030400206083	100pcs
W	40x20x6	24-30 S	9030400206085	100pcs
W	50x10x6	24-30 Q	9030500106083	100pcs

GLOBE shaft-mounted wheels are suitable for grinding and finishing operations. The different specifications can be distinguished by the color:



BLACK | **STAINLESS STEEL**



PINK | **STEEL**



GREY-PINK | **CAST IRON**

ON DEMAND:
shaft mounted wheels can be manufactured with 8 mm shaft or threaded shaft with 30% price increase. Available in different shapes.

NOTES FOR USE:
for a better performance, keep the projecting "e" distance in the grinder, as small as possible.

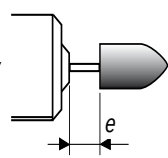

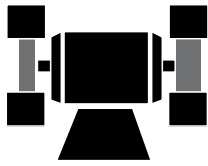

BENCH WHEELS FOR BENCH GRINDERS



Bore reducing adapter.

ABRASIVE	DIMENSIONS (diam - thick. - bore) mm	HARDNESS	ARTICLE CODE	
CORUNDUM: with 96% aluminum oxide content.	150x20x32,00	A 36	G4732 •	1pc
	150x20x32,00	A 46	G4733 •	1pc
	150x20x32,00	A 60	G4734 •	1pc
	200x20x32,00	A 36	G4752 •	1pc
	200x20x32,00	A 46	G4753 •	1pc
	200x20x32,00	A 60	G4754 •	1pc
	200x25x32,00	A 36	G4772 •	1pc
	200x25x32,00	A 46	G4773 •	1pc
200x25x32,00	A 60	G4774 •	1pc	

GLOBE bench wheels are specifically designed for removal of welding burrs, grinding, shaping and sharpening tools. GLOBE offers a wide range of sizes and specifications to fit all customers' needs. Depending on the abrasive mixture, GLOBE bench wheels are in 3 different colors, each identifying a specific use.

Hardness: medium.

Use: for general purpose grinding operations (tools sharpening) and light stock removal. It can be used on ferrous metals (carbon steel, stainless steel, etc.).

Available grits: from gr 24 (roughing operations) to gr 120 (sharpening and finishing).

ABRASIVE	DIMENSIONS (diam - thick. - bore) mm	HARDNESS	ARTICLE CODE	
WHITE CORUNDUM: with 99,5% aluminum oxide content.	150x20x32,00	A 60	G4735 •	1pc
	200x20x32,00	A 60	G4755 •	1pc
	200x25x32,00	A 60	G4775 •	1pc

Hardness: medium soft.

Use: particularly suitable for grinding and sharpening of high speed steel tools (HSS) and other metals. Thanks to this abrasive mixture, the maximum stock removal and grinding speed can be reached without overheating the work piece.

Available grits: from gr 46 (roughing operations), to gr 80 (sharpening).

ABRASIVE	DIMENSIONS (diam - thick. - bore) mm	HARDNESS	ARTICLE CODE	
GREEN SILICON CARBIDE:	150x20x32,00	C 80	G4736 •	1pc
	200x20x32,00	C 80	G4756 •	1pc
	200x25x32,00	C 80	G4776 •	1pc

Hardness: hard.

Use: ideal to work on hard steel tools (widia). Thanks to its extremely hard and sharp grain a very fast and burr-free grinding can be achieved.

Available grits: from gr 60 to gr 120.



Bore adapter from 32,00 to 16/20,00mm.



Tools sharpening, metals cleaning...



59

FIBERGLASS BACKING PAD (FLAT AND CONICAL)

HT - High Thickness (FOR PORTABLE ANGLE GRINDERS)
 STANDARD (FOR PORTABLE ANGLE GRINDERS)
 BASIC (FOR PORTABLE ANGLE GRINDERS)



61

PLASTIC BACKING PAD (FLAT)

HT - High Thickness (FOR PORTABLE ANGLE GRINDERS)
 STANDARD (FOR PORTABLE ANGLE GRINDERS)
 BASIC (FOR PORTABLE ANGLE GRINDERS)



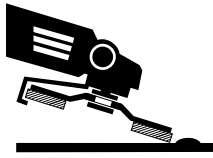

FLAPS' SHAPES OF GLOBE FLAP DISCS



GLOBE offers a wide range of abrasive flap discs manufactured and tested in compliance with the European regulations according to the maximum safety levels (EN13743) of the product. The high quality abrasive cloths assures a regular consumption and excellent grain renewal and cutting. Flaps are carefully positioned to get perfect roundness and balancing for a precise and comfortable work without vibrations and overheating. For special applications, discs with reduced diameter backing pads are available on demand. In these discs the prominent part of flaps is greater to give more elasticity and softness. Cloth mounting can be made in 3 different ways:

- **HT (High Thickness)**
- **STANDARD**
- **BASIC**

HT (HIGH THICKNESS)

In this mounting shape, flaps are narrower but in bigger number, giving the disc a higher, more compact and narrower abrasive crown cloth with more inclined flaps, bringing the following advantages:

- regular and full consumption of abrasive cloth (in standard discs 1/3 of the cloth is left unused) minimizing the waste of abrasive;
- increased removal speed thanks to the greater concentration of cloth on the outer part of the disc where speed is higher;
- constant removal capacity from the beginning to the end of the disc thanks to the special mounting layout of the flaps that, being in bigger number, are more inclined than those of standard discs, giving better and constant renewal of abrasive grains. The higher quality of the cloth assures top level performances in durability and removal speed. It is recommended to use with powerful grinders (at least 1000 Watts) to maximize performances.

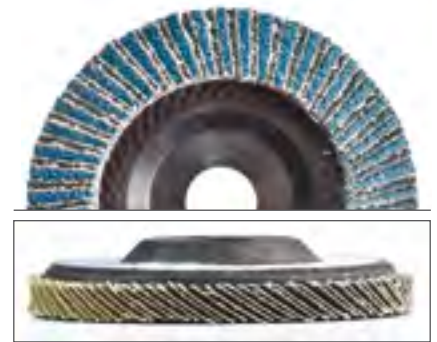

STANDARD

Flaps are larger and in a lower number than the HT version. This mounting shape, less aggressive, is more suitable to work on the edges and on more "delicate" materials. Suitable also for less powerful grinders. Discs with this mounting shape have alternate flaps of different hardness to get more efficient and constant renewal of abrasive grains even if flaps are less inclined.

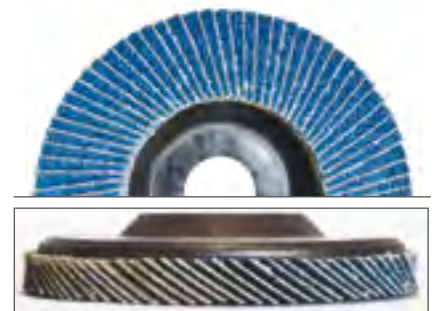

BASIC

The BASIC range is the GLOBE ENTRY LEVEL line. It keeps a good quality level with high removal capacity and good lifetime at a lower price level. Especially conceived for the large-scale retail trade. The cloth used is softer than the HT and STANDARD versions, allowing a constant change of the abrasive grains. Also suitable for less powerful grinders.

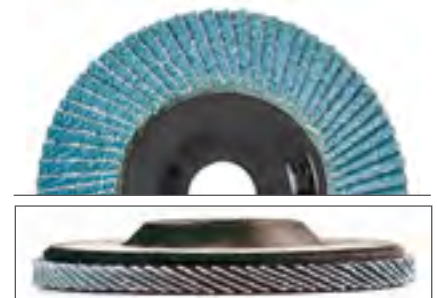

MOUNTING SHAPES AVAILABLE

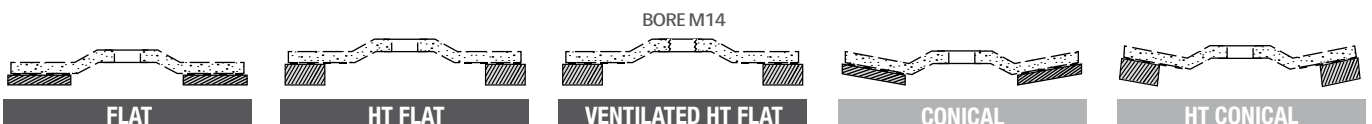

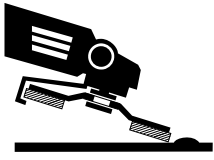

FLAP DISCS

- FIBERGLASS BACKING PAD
- FLAT OR CONICAL SHAPE

FLAP DISCS



Thanks to the fiberglass backing pad, these flap discs cannot pollute the surface worked; while this occurs during grinding operations with discs having a plastic backing pad. This phenomenon can occur once the abrasive cloth is used: for this reason flap discs with fiberglass backing pad are especially suitable for working stainless steel.

HT (HIGH THICKNESS)

APPLICATION TYPE OF CLOTH	DIMENSIONS (diam - bore) mm	GRIT	FLAT VERSION ART. CODE	CONICAL VERSION ART. CODE	
STAINLESS STEEL AND STEEL ALUMINA ZIRCONIA	HT				
	115x22,23	Z 40	G2812 HT •		20pcs
	115x22,23	Z 60	G2814 HT		20pcs
	115x22,23	Z 80	G2815 HT		20pcs
	125x22,23	Z 40	G2822 HT	G2822 C HT	20pcs
	125x22,23	Z 60	G2824 HT	G2824 C HT	20pcs
	125x22,23	Z 80	G2825 HT		20pcs

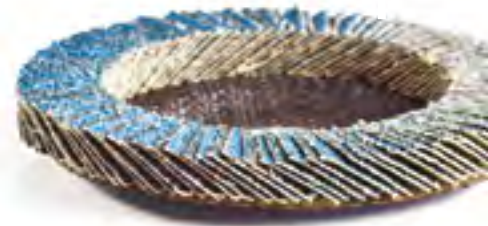

HT: high thickness mounting. Recommended for grinders of more than 1000 Watts. Disc for professionals.

STANDARD

APPLICATION TYPE OF CLOTH	DIMENSIONS (diam - bore) mm	GRIT	FLAT VERSION ART. CODE	CONICAL VERSION ART. CODE	
STEEL ALUMINUM OXIDE	TOP				
	115x22,23	A 36	G2611		20pcs
	115x22,23	A 40	G2612 •		20pcs
	115x22,23	A 60	G2614 •		20pcs
	125x22,23	A 40	G2622 •		20pcs
	125x22,23	A 60	G2624 •		20pcs
	180x22,23	A 40	G2712 •		10pcs
	180x22,23	A 60	G2714 •		10pcs



TOP: top range disc. Perfect for working carbon steel. High removal capacity, long durability.

STAINLESS STEEL AND STEEL ALUMINA ZIRCONIA	TOP				
	100x16,00	Z 40		G2802 C	20pcs
	100x16,00	Z 60		G2804 C	20pcs
	100x16,00	Z 80		G2805 C	20pcs
	115x22,23	Z 40	G2812 •	G2812 C •	20pcs
	115x22,23	Z 60	G2814 •	G2814 C •	20pcs
	115x22,23	Z 80	G2815 •	G2815 C	20pcs
	115x22,23	Z 120	G2817 •	G2817 C	20pcs
	125x22,23	Z 40	G2822 •	G2822 C •	20pcs
	125x22,23	Z 60	G2824 •	G2824 C •	20pcs
	125x22,23	Z 80	G2825	G2825 C	20pcs
	125x22,23	Z 120	G2827	G2827 C	20pcs
	180x22,23	Z 40	G2912 •		10pcs
	180x22,23	Z 60	G2914 •		10pcs
	180x22,23	Z 120	G2917		10pcs



TOP: top range disc. Ideal for working stainless steel. High removal capacity, long durability.

STANDARD

APPLICATION TYPE OF CLOTH	DIMENSIONS (diam - bore) mm	GRIT	FLAT VERSION ART. CODE	CONICAL VERSION ART. CODE	
---------------------------	-----------------------------	------	------------------------	---------------------------	---

TOP

115x22,23	CER 40	G2852 •	G2852 C	20pcs
125x22,23	CER 40	G2862 •	G2862 C	20pcs

 STAINLESS STEEL AND STEEL

 CERAMIC GRAIN



TOP CER: the top range disc with ceramic cloth. To be used on grinders of more than 1000 Watts to obtain excellent results.

BASIC

APPLICATION TYPE OF CLOTH	DIMENSIONS (diam - bore) mm	GRIT	FLAT VERSION ART. CODE	CONICAL VERSION ART. CODE	
---------------------------	-----------------------------	------	------------------------	---------------------------	---

MAXI

NEW 115x22,23	Z 40	G2812 80 •		20pcs
NEW 115x22,23	Z 60	G2814 80 •		20pcs
NEW 125x22,23	Z 40		G2822 C 90 •	20pcs
NEW 125x22,23	Z 60		G2824 C 90 •	20pcs

 STAINLESS STEEL AND STEEL

 ALUMINA ZIRCONIA



MAXI: alumina zirconia disc. The number of flaps (80/90) and their arrangement make it compact and precise. Excellent quality/price ratio.

GF

115x22,23	Z 40	GF2812 •	GF2812 C	20pcs
115x22,23	Z 60	GF2814 •	GF2814 C	20pcs
115x22,23	Z 80	GF2815 •	GF2815 C	20pcs
115x22,23	Z 120	GF2817 •	GF2817 C	20pcs
125x22,23	Z 40	GF2822 •	GF2822 C	20pcs
125x22,23	Z 60	GF2824 •	GF2824 C	20pcs
125x22,23	Z 80	GF2825 •	GF2825 C	20pcs
125x22,23	Z 120	GF2827 •	GF2827 C	20pcs
180x22,23	Z 40	GF2912		10pcs
180x22,23	Z 60	GF2914		10pcs
180x22,23	Z 80	GF2915		10pcs

 STAINLESS STEEL AND STEEL

 ALUMINA ZIRCONIA



GF: the GLOBE intermediate range that guarantees good performances and user comfort with any grinder. Good quality/price ratio.

GF EKO

115x22,23	Z 40	GF2812 EKO 1K D •		500pcs
115x22,23	Z 40	GF2812 EKO 1K S •		500pcs
115x22,23	Z 60	GF2814 EKO 1K D •		500pcs
115x22,23	Z 60	GF2814 EKO 1K S •		500pcs



GF EKO: GLOBE base line that guarantees good performance and comfort of use with any machine. Good value for money.

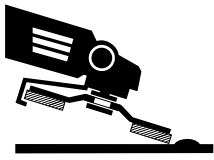

FLAP DISCS

- PLASTIC BACKING PAD
- FLAT VERSION



Compared to the fiberglass backing pad, the plastic one gives greater rigidity to the disc. Available in HT version (with narrow crown), standard version or in economical version with both zirconium cloths (suitable for grinding and finishing all types of steel, also alloyed) and corundum cloths (suitable for iron and steel). Discs with plastic backing pad as well as those with fiberglass backing pad are manufactured and tested in compliance with European standards respecting the maximum safety (EN13743). Among its innovations, GLOBE is proud to present the **VORTEX HT** and **COMPACT** discs.

VORTEX HT is the most advanced flap disc currently on the market, featuring innovations and technical solutions that make it unique.

- Ventilating aerodynamic fins: produce a ventilating and cooling effect; the workpiece remains colder with less risk of pitting (particularly important for stainless steel); the abrasive cloth is subject to less overheating, less wear and this makes the disc more durable.
- Threaded bore: allows quick and easy fixing without wrenches.
- The HT arrangement of flaps allows a very high abrading capacity and working speed as well as a constant performance from the beginning to the end of the disc. Furthermore, the arrangement of abrasive mixture in the peripheral area of the disc, minimizes wasted material when the disc is finished.

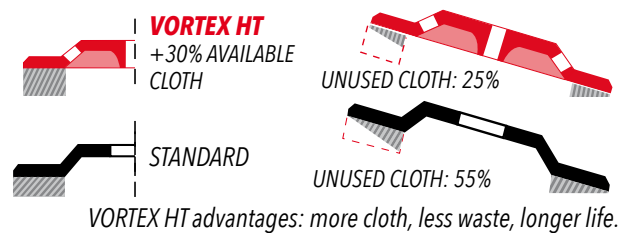
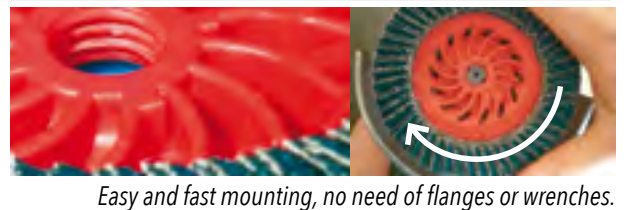
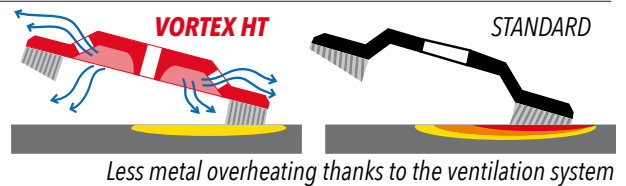

COMPACT is GLOBE answer to some applications that need a rigid and compact product. The special structure of the plastic backing pad and the arrangement of the flaps allow to obtain a high rigidity and density of the flap structure giving the disc particularly advantageous abrading properties. In particular, flaps so arranged do not yield under pressure, allowing to work accurately and precisely the desired metal part without affecting surrounding areas. Even when working with the disc inclined, flaps remain firm and rigid, allowing an accurate and fast work. The high quality cloth is durable and high-performing, reducing working times and costs.

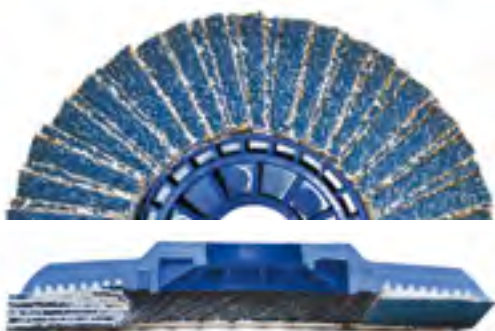

HT (HIGH THICKNESS)

APPLICATION TYPE OF CLOTH	DIMENSIONS (diam - bore) mm	GRIT	FLAT VERSION ART. CODE	
---------------------------	-----------------------------	------	------------------------	---

HT



 STEEL	115x22,23	A 40	G3012 HT	20pcs
--	-----------	------	----------	-------

 ALUMINUM OXIDE



HT: assembly with High Thickness flaps. Recommended for grinders of more than 1000 Watts. Disc for professionals.



HT

 STAINLESS STEEL AND STEEL	115x22,23	Z 40	G3112 HT •	20pcs
	115x22,23	Z 60	G3114 HT •	20pcs
	115x22,23	Z 80	G3115 HT	20pcs
	115x22,23	Z 120	G3117 HT	20pcs
 ALUMINA ZIRCONIA	125x22,23	Z 40	G3132 HT	20pcs
	125x22,23	Z 60	G3134 HT	20pcs
	125x22,23	Z 80	G3135 HT	20pcs



HT: High Thickness mounting. Recommended for grinders of more than 1000 Watts. Disc for professionals.

VORTEX HT

 STAINLESS STEEL AND STEEL	115xM14	Z 40	G3112 HTV •	20pcs
	115xM14	Z 60	G3114 HTV •	20pcs
	115xM14	Z 80	G3115 HTV	20pcs
 ALUMINA ZIRCONIA	125xM14	Z 40	G3132 HTV	20pcs
	125xM14	Z 60	G3134 HTV	20pcs
	125xM14	Z 80	G3135 HTV	20pcs

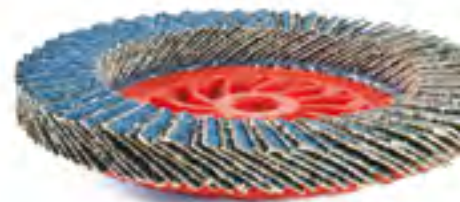

HT VORTEX: ventilated backing pad and High Thickness assembly. Recommended for grinders of more than 1000 Watts. Disc for professionals.

CERAMIC HT

 STAINLESS STEEL AND STEEL	115x22,23	CER 40	G3152 HT •	20pcs
--	-----------	--------	------------	-------

 CERAMIC GRAIN





HT CER: High Thickness mounting. Recommended for grinders of more than 1000 Watts. Disc for professionals.

STANDARD

APPLICATION TYPE OF CLOTH	DIMENSIONS (diam - bore) mm	GRIT	FLAT VERSION ART. CODE	
---------------------------	-----------------------------	------	------------------------	---



TOP

 STEEL	115x22,23	A 36	G3011	20pcs
	115x22,23	A 40	G3012 •	20pcs
	115x22,23	A 60	G3014 •	20pcs
 ALUMINUM OXIDE	180x22,23	A 40	G3022 •	10pcs
	180x22,23	A 60	G3024 •	10pcs



TOP: assembly with High Thickness flaps. Recommended for grinders of more than 1000 Watts. Disc for professionals. Exceptional performances.

TOP

 STAINLESS STEEL AND STEEL	115x22,23	Z 36	G3111	20pcs
	115x22,23	Z 40	G3112 •	20pcs
	115x22,23	Z 60	G3114 •	20pcs
	115x22,23	Z 80	G3115 •	20pcs
	115x22,23	Z 120	G3117 •	20pcs
 ALUMINA ZIRCONIA	125x22,23	Z 40	G3132 •	20pcs
	125x22,23	Z 60	G3134 •	20pcs
	125x22,23	Z 80	G3135 •	20pcs
	180x22,23	Z 40	G3122 •	10pcs
	180x22,23	Z 60	G3124 •	10pcs



TOP: top of the range disc with standard assembly of flaps. Long durability assured. High removal capacity.

STANDARD

APPLICATION TYPE OF CLOTH	DIMENSIONS (diam - bore) mm	GRIT	FLAT VERSION ART. CODE	
---------------------------	-----------------------------	------	------------------------	---

 **STAINLESS STEEL AND STEEL**

 ALUMINA ZIRCONIA

COMPACT

115x22,23	Z 40	G3112 COM •	20pcs
115x22,23	Z 60	G3114 COM •	20pcs
115x22,23	Z 80	G3115 COM •	20pcs



COMPACT:
reverse conical plastic backing pad that makes the disc rigid and compact on the outer edge. Ideal for working sheet metals.

 **ALUMINIUM** *NEW*

 ALUMINUM OXIDE WITH ZIRCONIUM STEARATE

ALU

115x22,23	A 40 QAL	G3012 •	20pcs
-----------	----------	---------	-------



ALUMINIUM:
Disc specifically designed for aluminium. Extraordinary durability. It doesn't clog.

BASIC

APPLICATION TYPE OF CLOTH	DIMENSIONS (diam - bore) mm	GRIT	FLAT VERSION ART. CODE	
---------------------------	-----------------------------	------	------------------------	---

 **STAINLESS STEEL AND STEEL**

 ALUMINA ZIRCONIA

RAPID PLUS

<i>NEW</i>	115x22,23	Z 40	G3112 R •	20pcs
<i>NEW</i>	115x22,23	Z 60	G3114 R •	20pcs
<i>NEW</i>	115x22,23	Z 80	G3115 R •	20pcs
<i>NEW</i>	125x22,23	Z 40	G3132 R •	20pcs
<i>NEW</i>	125x22,23	Z 60	G3134 R •	20pcs

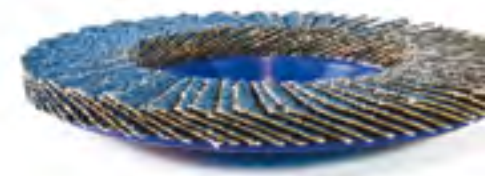

RAPID PLUS:
improvement of the Rapid disc. More durability and removal speed.

GF

115x22,23	Z 40	GF3112 •	20pcs
115x22,23	Z 60	GF3114 •	20pcs
115x22,23	Z 80	GF3115 •	20pcs
115x22,23	Z120	GF3117 •	20pcs

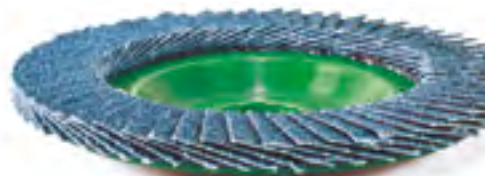

GF:
intermediate range with plastic backing pad.

GF EKO

<i>NEW</i>	115x22,23	Z 40	GF3112 EKO 1K D •	500pz
<i>NEW</i>	115x22,23	Z 40	GF3112 EKO 1K S •	500pz
<i>NEW</i>	115x22,23	Z 60	GF3114 EKO 1K D •	500pz
<i>NEW</i>	115x22,23	Z 60	GF3114 EKO 1K S •	500pz
<i>NEW</i>	115x22,23	Z 40	GF3132 EKO •	20pz
<i>NEW</i>	115x22,23	Z 60	GF3134 EKO •	20pz



GF - EKO:
the new economical disc with plastic backing pad.

 **STEEL**

 ALUMINUM OXIDE

GF

115x22,23	A 40	GF3012 •	20pcs
115x22,23	A 60	GF3014 •	20pcs

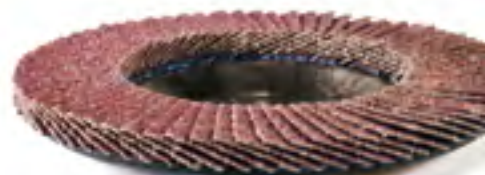

GF:
intermediate range with plastic backing pad.

• = articles always in stock



FLEXIBLE ABRASIVES



ABRASIVE CLOTHS AND PAPERS

- 66 ABRASIVE CLOTHS (BELT, SHEETS, MINI ROLLS AND ROLLS)
- 68 ABRASIVE PAPERS (ROLLS AND SHEETS)



SHAFT MOUNTED FLAP WHEELS AND FLAP WHEELS

- 69 SHAFT MOUNTED FLAP WHEELS (FOR PORTABLE STRAIGHT GRINDERS)
- 70 FLAP WHEELS (FOR BENCH GRINDERS)



FIBER DISCS

- 73 (FOR PORTABLE ANGLE GRINDERS)



542 JFF

We recommend its use with soft contact wheels for grinding and finishing of shaped parts, or for wood sanding. Excellent versatility and adaptability to the work-piece shape. Examples: taps, surgical tools.

552 JFF

Very good adaptability on highly shaped parts and on soft metals such as pewter, zamak, aluminium, brass, knives and profiles. Coolants and lubricants avoid belt clogging and decrease frictional heating.

531 JFF

Especially indicated on narrow radii less than 5 mm, very flexible product. Very good performance on wood profiles with shaped pad, prostheses, surgical instruments knives' blades.

641 PF

Hand grinding of metals, finishing of profiles, machine parts' cylinders and goosenecks. Examples: tapware, surgical instruments...

541 JF

Very versatile, for roughing and finishing of metals on semi-hard or soft contact wheels, especially on aluminium and soft metals in general. Also suitable for wood. Good anchoring of abrasive, granules' toughness.

KK 511 J

Common steels, bronze, brass. Fittings, shaped parts. Suitable for manual, automatic and robotic grinding.

KK 711 T

Fittings, tools, cutlery. Good removal capacity and flexibility, enough to grind radii of more than 5mm. Manual, automatic and robotic grinding and with angle grinders as well.

642 X FN

Versatile, for dry grinding of metals in general, with XF support of soft cotton.

KK 711 X

Common steel, alloy steel, stainless steel, bronze, brass, aluminium, castings. Fittings, tools, cutlery, tubes and bars, forged parts, furniture parts. Excellent performance, versatility, water and emulsion resistant up to grit 80. Exceptional grip of abrasive on edge workings, such as grinding of aluminium parts.

KK 711 Y

Wet grinding (water or emulsion) of metals in general. Excellent in finishing brass or aluminium tubes, common or alloy steel. Very stable water-resistant support, very tough abrasive grit.

KK 813 X

Belt grinding of flat metal surfaces. Removal of forging burrs and correction of non-uniform surfaces. Removal of weld beads. Stainless steel sinks and tanks. Excellent on ally steels. Additives minimize frictional heating. Good removal capacity.

942 J

Belt grinding, on contact wheel from medium-hard to soft, brass, zamak, cast iron, ceramics. Very sharp abrasive, excellent adaptability of the support

CK 721 X

Also wet working of stainless steel, titanium, bronze, brass, hard wood, mdf, fillers, paints, glass, ceramics, stone, marble, rubber, synthetic materials and ceramics. Versatile product, excellent cutting capacity and aggressiveness. Water-resistant support up to grit 180.

341 X

Grinding on hard or semi-hard contact wheels, metals, flat grinding, wooden floor smoothing,. Good performance and durability, stable support, excellent anchoring of abrasive.

ZK 713 X

Common steel, alloy steel and stainless steel, bronze, brass, aluminium and fusions. Polyester support. Tools, cutlery, furniture, forged parts, tubes and bars. Water and emulsion resistant.

XK 760 X

Extremely aggressive ceramic product. Very high resistance to oils and water. Exceptional performances in wet grinding of stainless steel tubes and bars and for dry grinding of carbon steel.

SK 850 X

Expressly studied for working stainless steel. Excellent for removing weld beads (stainless steel sinks) and where a high removal is needed. Extremely resistant support. Coolants for cutting.

XK 870 F

Very good adaptability to shaped parts. Common steel and alloy steel, aluminium, fusions, titanium alloys, bronze, brass. Tubes and bars, forged parts, knives, microfusions, surgical prostheses. Excellent durability, cutting and aggressiveness. With coolants and lubricants.

XK 870 X

Common steel, alloy steel, stainless steel, aluminium, fusions, titanium alloys, bronze, fusions, brass. Tubes and bars, metal furniture, surgical prostheses, microfusions. Exceptional cold cut thanks to additives and aggressiveness. Excellent regeneration of abrasive grains.

KK 712 X - Compact grain product with exceptional durability, finishing smoothness, drastic decrease of idle machine time, and of abrasive cost for the worked part. Dry or wet working on common and alloy steel, flat or cylindrical. Big time and cost saving for users.

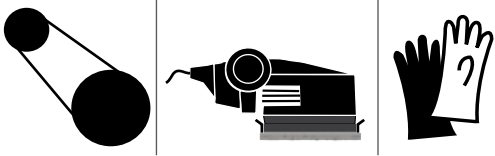

ABRASIVE CLOTH: BELTS, ANTI-WASTE SHEETS, MINI ROLLS AND ROLLS



BELTS

SPECIFICATIONS (composition - workable materials - operations)	DIMENSIONS (height x length) mm	GRIT									
		24	36	40	60	80	100	120	150	180	

- COMPOSITION**
 Aluminum oxide cloth type 642 X FN. Strong X cotton backing.

WORKABLE MATERIALS AND OPERATIONS

All types of metals. Also for wood sanding. Dry grinding.

203x750	●	●	●	●	●	●	●	●	●	●	on demand
100x1.000	●	●	●	●	●	●	●	●	●	●	on demand
120x1.500	●	●	◀	◀	●	●	●	●	●	●	on demand
150x1.750	●	●	●	●	●	●	●	●	●	●	on demand
75x2.000	●	●	●	●	●	●	●	●	●	●	on demand
150x2.000	●	●	●	●	●	●	●	●	●	●	on demand
100x2.500	●	●	●	●	●	●	●	●	●	●	on demand

SPECIFICATIONS (composition - workable materials - operations)	DIMENSIONS (height x length) mm	GRIT				
		24	36	40	60	

- COMPOSITION**
 Zirconia cloth, type 341 X. X cotton backing.

WORKABLE MATERIALS AND OPERATIONS

Stainless steel and parquet sanding. Dry grinding on carbon steel.

203x750	●	●	●	●	●	●	●	●	on demand
100x1.000	●	●	●	●	●	●	●	●	on demand
120x1.500	●	●	◀	◀	●	●	●	●	on demand
150x1.750	●	●	●	●	●	●	●	●	on demand
75x2.000	●	●	●	●	●	●	●	●	on demand
150x2.000	●	●	●	●	●	●	●	●	on demand
100x2.500	●	●	●	●	●	●	●	●	on demand

ANTI-WASTE SHEETS

SPECIFICATIONS (composition - workable materials - operations)	DIMENSIONS (height x length) mm	GRIT				
		60	80	100	120	

- COMPOSITION**
 Aluminum oxide type 641 PF. Flexible cotton backing.

WORKABLE MATERIALS AND OPERATIONS

Suitable for manual grinding.

230x280	●	●	●	●	●	●	●	●	50pcs
---------	---	---	---	---	---	---	---	---	-------

ANTI-WASTE MINI ROLLS

SPECIFICATIONS (composition - workable materials - operations)	DIMENSIONS (height x length) mm	GRIT							
		60	80	120	150	180	240	400	

<p>COMPOSITION Type 641 PF aluminum oxide, flexible cotton backing.</p> <p>WORKABLE MATERIALS AND OPERATIONS For manual grinding.</p>	115x5.000	●	▼	●	▼	●	▼	●	▼	●	▼	●	▼	5mt
---	-----------	---	---	---	---	---	---	---	---	---	---	---	---	-----

ANTI-WASTE ROLLS

SPECIFICATIONS (composition - workable materials - operations)	DIMENSIONS (height x length) mm	GRIT										
		40	50	60	80	100	120	150	180	220	240	

<p>COMPOSITION Type 641 PF aluminum oxide cloth, X flexible cotton backing, strong backing, good anchoring of abrasive grains.</p> <p>WORKABLE MATERIALS AND OPERATIONS All types of materials (not boxed roll).</p>	25x50.000	●	●	●	●	●	●	●	●	●	●	●	●	50mt
	40x50.000	●	●	●	●	●	●	●	●	●	●	●	●	50mt

DIMENSIONS (height x length) mm	40	50	60	80	100	120	150	180	220	240	320	400	
------------------------------------	----	----	----	----	-----	-----	-----	-----	-----	-----	-----	-----	---

50x50.000	●	●	●	●	●	●	●	●	●	●	●	●	50mt
-----------	---	---	---	---	---	---	---	---	---	---	---	---	------

DIMENSIONS (height x length) mm	40	50	60	80	100	120	150	180	220	240	280	320	400	600	
------------------------------------	----	----	----	----	-----	-----	-----	-----	-----	-----	-----	-----	-----	-----	---

115x50.000	●	▼	●	▼	●	▼	●	▼	●	▼	●	▼	●	▼	50mt
------------	---	---	---	---	---	---	---	---	---	---	---	---	---	---	------

SPECIFICATIONS (composition - workable materials - operations)	DIMENSIONS (height x length) mm	GRIT							
		40	50	60	80	100	120	150	

<p>COMPOSITION Type 531 J FF aluminum oxide cloth, X extra-flexible cotton backing,</p> <p>WORKABLE MATERIALS AND OPERATIONS Ideal for grinding of concave or convex surfaces (not boxed roll).</p>	50x50.000	●	●	●	●	●	●	●	●	●	●	●	●	50mt
	115x50.000	●	●	●	●	●	●	●	●	●	●	●	●	50mt

SPECIFICATIONS (composition - workable materials - operations)	DIMENSIONS (height x length) mm	GRIT							
		40	50	60	80	100	120	150	

<p>COMPOSITION Type KK 114 F aluminum oxide cloth X flexible cotton backing.</p> <p>WORKABLE MATERIALS AND OPERATIONS Excellent on all materials. Manual use (boxed roll).</p>	25x50.000	●	●	●	●	●	●	●	●	●	●	●	●	50mt
	40x50.000	●	●	●	●	●	●	●	●	●	●	●	●	50mt
	50x50.000	●	●	●	●	●	●	●	●	●	●	●	●	50mt

SPECIFICATIONS (composition - workable materials - operations)	DIMENSIONS (height x length) mm	GRIT							
		40	50	60	80	100	120	150	

<p>COMPOSITION Type 531 J FF aluminum oxide cloth, X extra-flexible cotton backing.</p> <p>WORKABLE MATERIALS AND OPERATIONS Excellent on all materials. Manual use (boxed roll).</p>	50x50.000	●	●	●	●	●	●	●	●	●	●	●	●	50mt
---	-----------	---	---	---	---	---	---	---	---	---	---	---	---	------



ABRASIVE PAPERS: ROLLS AND SHEETS



ROLLS

SPECIFICATIONS (composition - workable materials - operations)	DIMENSIONS (height x length) mm	GRIT										
		40	60	80	100	120	150	180	220	240	280	

● COMPOSITION

Aluminum oxide paper.
542 C7 paper
from gr. 40 up to gr.120 (weight C).
542 B7 paper
from gr.150 up to gr.400 (weight B).

WORKABLE MATERIALS AND OPERATIONS

For manual use on wood,
stucco and paints.

115x50.000	●	●	●	●	●	●	●	●	●	●	●	●	50mt
------------	---	---	---	---	---	---	---	---	---	---	---	---	------

SHEETS

SPECIFICATIONS (composition - workable materials - operations)	DIMENSIONS (height x length) mm	GRIT								
		60	80	100	120	150	180	220	240	

● COMPOSITION

Aluminum oxide paper.
542 C7 paper
from gr. 40 up to gr.120 (weight C).
542 B7 paper
from gr.150 up to gr.400 (weight B).

WORKABLE MATERIALS AND OPERATIONS

For manual working on wood,
stucco, paint.

230x280	●	●	●	●	●	●	●	●	●	●	50pcs
---------	---	---	---	---	---	---	---	---	---	---	-------

SPECIFICATIONS (composition - workable materials - operations)	DIMENSIONS (height x length) mm	GRIT								
		80	100	120	150	180	220	240	280	

● COMPOSITION

Silicon carbide paper.
991 C paper
from gr. 80 up to gr. 1000.
991 A paper
from gr.1200 up to gr. 5000.

WORKABLE MATERIALS AND OPERATIONS

Stucco, paint glass, also used for car
body repairs. Manual workings.

230x280	●	●	●	●	●	●	●	●	●	●	50pcs
---------	---	---	---	---	---	---	---	---	---	---	-------



SHAFT MOUNTED FLAP WHEELS FOR PORTABLE STRAIGHT GRINDERS OR DRILLS

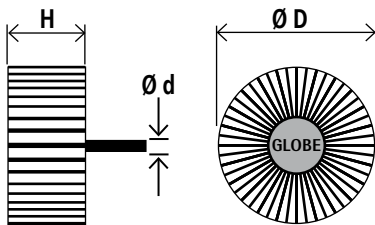

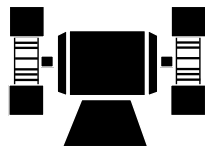

GLOBE SHAFT-MOUNTED FLAP WHEELS are characterized by top quality cloth and excellent fabric of the support cloth that doesn't burn during use and doesn't produce bad smells; it wears evenly ensuring excellent change and cutting rate. Wheels with 8 mm shaft can be manufactured on request. Thanks to the noiselessness during use and perfect balancing, they represent an excellent tool for finishing and satinizing. Zirconia wheels are available with 15% price increase, minimum order quantity is 100 pieces per type. Add suffix "Z" to the article code of corundum wheels.

DIMENSIONS (mm)			ART. COD.	ART. COD.	ART. COD.	ART. COD.	ART. COD.	ART. COD.	ART. COD.	 pcs
DIAM. (D)	THICK. (H)	SHAFT (d)	GRIT 40	GRIT 60	GRIT 80	GRIT 120	GRIT 180	GRIT 220	GRIT 320	
30	10	6	G4011 •	G4012	G4013 •	G4014	G4015	G4016	G4017	25
30	15	6	G4021	G4022 •	G4023	G4024	G4025	G4026	G4027	25
30	20	6	G4031 •	G4032 •	G4033 •	G4034	G4035	G4036	G4037	25
40	10	6	G4111	G4112 •	G4113	G4114	G4115	G4116	G4117	25
40	15	6	G4121	G4122 •	G4123	G4124	G4125	G4126	G4127	25
40	20	6	G4131 •	G4132 •	G4133 •	G4134	G4135	G4136	G4137	25
40	25	6	G4141	G4142	G4143 •	G4144	G4145	G4146	G4147	25
40	30	6	G4151 •	G4152 •	G4153 •	G4154	G4155	G4156	G4157	25
50	10	6	G4211	G4212 •	G4213 •	G4214	G4215	G4216	G4217	25
50	15	6	G4221	G4222 •	G4223 •	G4224	G4225	G4226	G4227	25
50	20	6	G4231 •	G4232 •	G4233 •	G4234	G4235	G4236	G4237	25
50	25	6	G4241	G4242	G4243	G4244	G4245	G4246	G4247	25
50	30	6	G4251 •	G4252 •	G4253 •	G4254	G4255	G4256	G4257	25
60	15	6	G4311 •	G4312	G4313 •	G4314	G4315	G4316	G4317	25
60	20	6	G4321	G4322 •	G4323	G4324	G4325	G4326	G4327	25
60	25	6	G4331	G4332	G4333	G4334	G4335	G4336	G4337	25
60	30	6	G4341 •	G4342 •	G4343 •	G4344	G4345	G4346	G4347	25
60	40	6	G4351 •	G4352 •	G4353 •	G4354	G4355	G4356	G4357	25
60	50	6	G4361	G4362 •	G4363	G4364	G4365	G4366	G4367	25
80	20	6	G4421 •	G4422 •	G4423 •	G4424	G4425	G4426	G4427	25
80	30	6	G4431 •	G4432 •	G4433 •	G4434	G4435	G4436	G4437	25
80	40	6	G4441	G4442 •	G4443	G4444	G4445	G4446	G4447	25
80	50	6	G4451 •	G4452	G4453	G4454	G4455	G4456	G4457	25

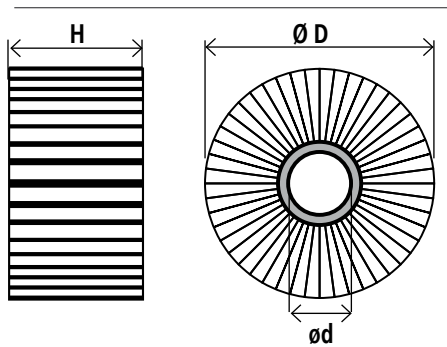

ABRASIVE FLAP WHEELS FOR BENCH GRINDERS



DIMENSIONS (mm)			ART. CODE	ART. CODE	ART. CODE	ART. CODE	ART. CODE	ART. CODE	
DIAM. (D)	THICK. (H)	BORE (d)	GRIT 40	GRIT 50	GRIT 60	GRIT 80	GRIT 100	GRIT 120	
100	30	26,00	G4511	G4512	G4513	G4514	G4515	G4611	10
100	50	26,00	G4521	G4522	G4523	G4524	G4525	G4621	10
165	30	54,00	G4541 •	G4542	G4543 •	G4544 •	G4545	G4641 •	10
165	50	54,00	G4551	G4552	G4553	G4554	G4555	G4651	10
200	30	54,00	G4561 •	G4562	G4563	G4564	G4565	G4661	10
200	50	54,00	G4571	G4572	G4573	G4574	G4575	G4671	10
250	30	100,00	G4581	G4582	G4583	G4584	G4585	G4681	10
250	50	100,00	G4591	G4592	G4593	G4594	G4595	G4691	10

DIMENSIONS (mm)			ART. CODE	ART. CODE	ART. CODE	ART. CODE	ART. CODE	
DIAM. (D)	THICK. (H)	BORE (d)	GRIT 150	GRIT 180	GRIT 220	GRIT 240	GRIT 320	
100	30	26,00	G4612	G4613	G4614	G4615	G4616	10
100	50	26,00	G4622	G4623	G4624	G4625	G4626	10
165	30	54,00	G4642	G4643 •	G4644	G4645	G4646	10
165	50	54,00	G4652	G4653	G4654	G4655	G4656	10
200	30	54,00	G4662	G4663	G4664	G4665	G4666	10
200	50	54,00	G4672	G4673	G4674	G4675	G4676	10
250	30	100,00	G4682	G4683	G4684	G4685	G4686	10
250	50	100,00	G4692	G4693	G4694	G4695	G4696	10

FLANGE COUPLES TO REDUCE THE BORE OF FLAP WHEELS

ART. CODE	DESCRIPTION
2300000000100	flange couple to reduce bore in diam. 25,40 mm wheels
2300000000165	flange couple to reduce bore in diam. 54,80 mm wheels
2300000000250	flange couple to reduce bore in diam. 100,00 mm wheels

Zirconia wheels are available with 18% price increase, minimum order quantity per type is of 30 pieces. Add suffix "Z" to the aluminum oxide article code.

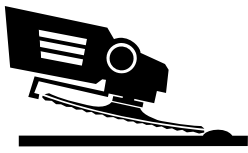

FIBER DISCS FOR PORTABLE ANGLE GRINDERS



GLOBE FIBER SANDING DISCS are manufactured with fibers of the best quality. Great care is taken to obtain a homogeneous and accurate distribution of abrasive. Abrasive grains, exposed to a high potential electrostatic field, always turn their points upwards in order to reach the best sharpness.

Mixtures, made with corundum, alumina zirconia or silicon carbide allow to reach excellent performances on iron, steel, stainless steel and materials for the building industry.

The special dressing, especially in the zirconium type, prevents overheating of work-pieces.

To be always used with the special backing pads.

GRIT: higher than 120 grit available on demand.



Ceramic grains viewed under a microscope.

AVAILABLE BACKING PADS:
 Ø115 (art. code G3400 115)
 Ø125 (art. code G3400 125) bore M14.
 For more informations: pag. 88.

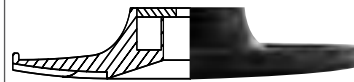

GLOBE backing pads.

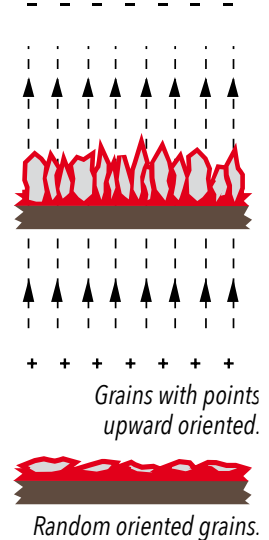

ABRASIVE MIXTURE WITH SPECIAL COOLING COMPOUNDS

Improves product performance, reduces heat development thus preserving worked surfaces from possible overheating, pitting, etc. and extends sanding discs' durability.

CERAMIC ABRASIVE GRAINS

The ceramic sanding disc is manufactured with an abrasive grit called ceramic, obtained by sintering of crystal alumina and with extraordinary features of grain hardness and toughness.

ELECTROSTATIC ORIENTATION OF GRAINS

During production process, abrasive grains are vertically oriented (through an electrostatic field with high potential difference) with their major axis perpendicular to the disc surface. This special treatment aligns grains' points and makes the product much more abrading and effective compared to discs obtained with a random and not oriented arrangement of grains.

ALL THE ADVANTAGES OF CERAMIC SANDING DISCS

- Very high removal, excellent finishing and great versatility
- Suitable for working all main metals such as: iron, carbon steel, alloy steel, stainless steel and aluminium.
- User comfort thanks to the absence of vibrations, lightness of the product and reduced noise emission.
- Very low powder production.
- Decrease in production costs and increase in productivity thanks to a very high removal, exceptional durability and user comfort decreasing work breaks.

A RENEWED RANGE OF CORUNDUM AND ZIRCONIUM SANDING DISCS

Besides the new ceramic sanding disc, GLOBE developed a new, completely renewed range of zirconium and corundum sanding discs that are able to obtain 20% higher performances than the previous formulation as well as a longer durability.

BACKING PADS

GLOBE sanding discs always have to be combined with our special backing pads to offer the best performance.



APPLICATION TYPE OF CLOTH		DIMENSIONS (mm)		ART. CODE	ART. CODE	ART. CODE	ART. CODE	ART. CODE	ART. CODE	ART. CODE	ART. CODE	ART. CODE	
DIAM.	BORE	GRIT 16	GRIT 24	GRIT 36	GRIT 40	GRIT 50	GRIT 60	GRIT 80	GRIT 100	GRIT 120			pcs
	STEEL CORUNDUM-TYPE 02A												
	100	22,23	G3411	G3412	G3413	G3414	G3415	G3416	G3417	G3418	G3419		50
	100	22,23	G3411 TOP	G3412 TOP	G3413 TOP	G3414 TOP	G3415 TOP	G3416 TOP	G3417 TOP	G3418 TOP	G3419 TOP		50
	115	22,23	G3421	G3422 ●	G3423 ●	G3424 ●	G3425	G3426 ●	G3427 ●	G3428 ●	G3429 ●		50
	115	22,23	G3421 TOP	G3422 TOP	G3423 TOP	G3424 TOP	G3425 TOP	G3426 TOP	G3427 TOP	G3428 TOP	G3429 TOP		50
	125	22,23	G3431	G3432	G3433 ●	G3434 ●	G3435	G3436 ●	G3437 ●	G3438	G3439		50
	125	22,23	G3431 TOP	G3432 TOP	G3433 TOP	G3434 TOP	G3435 TOP	G3436 TOP	G3437 TOP	G3438 TOP	G3439 TOP		50
	150	22,23	G3441	G3442	G3443	G3444	G3445	G3446	G3447	G3448	G3449		50
	150	22,23	G3441 TOP	G3442 TOP	G3443 TOP	G3444 TOP	G3445 TOP	G3446 TOP	G3447 TOP	G3448 TOP	G3449 TOP		50
	180	22,23	G3451 ●	G3452 ●	G3453 ●	G3454	G3455	G3456 ●	G3457	G3458	G3459		50
	180	22,23	G3451 TOP	G3452 TOP	G3453 TOP	G3454 TOP	G3455 TOP	G3456 TOP	G3457 TOP	G3458 TOP	G3459 TOP		50

	STAINLESS STEEL ZIRCONIUM-TYPE 03A												
	115	22,23	-	G3521	G3522 ●	G3523	G3524 ●	G3525 ●	G3526	G3527	G3528 ●		50
	115	22,23	-	G3521 TOP	G3522 TOP	G3523 TOP	G3524 TOP	G3525 TOP	G3526 TOP	G3527 TOP	G3528 TOP		50
	125	22,23	-	G3531 ●	G3532 ●	G3533 ●	G3534 ●	G3535 ●	G3536 ●	G3537 ●	G3538		50
	125	22,23	-	G3531 TOP	G3532 TOP	G3533 TOP	G3534 TOP	G3535 TOP	G3536 TOP	G3537 TOP	G3538 TOP		50
	150	22,23	-	G3541	G3542	G3543	G3544	G3545	G3546	G3547	G3548		50
	150	22,23	-	G3541 TOP	G3542 TOP	G3543 TOP	G3544 TOP	G3545 TOP	G3546 TOP	G3547 TOP	G3548 TOP		50
	180	22,23	-	G3551 ●	G3552 ●	G3553	G3554	G3555 ●	G3556	G3557	G3558		50
	180	22,23	-	G3551 TOP	G3552 TOP	G3553 TOP	G3554 TOP	G3555 TOP	G3556 TOP	G3557 TOP	G3558 TOP		50

	STONE SILICON CARBIDE-TYPE 02C												
	115	22,23	G3621	G3622	G3623	G3624	G3625	G3626	G3627	-	-		50
	115	22,23	G3621 TOP	G3622 TOP	G3623 TOP	G3624 TOP	G3625 TOP	G3626 TOP	G3627 TOP	-	-		50
	125	22,23	G3631	G3632	G3633	G3634	G3635	G3636	G3637	-	-		50
	125	22,23	G3631 TOP	G3632 TOP	G3633 TOP	G3634 TOP	G3635 TOP	G3636 TOP	G3637 TOP	-	-		50
	180	22,23	G3651	G3652	G3653	G3654	G3655	G3656	G3657	-	-		50
180	22,23	G3651 TOP	G3652 TOP	G3653 TOP	G3654 TOP	G3655 TOP	G3656 TOP	G3657 TOP	-	-		50	

	STAINLESS STEEL AND STEEL CERAMIC-TYPE 04A												
	115	22,23	-	-	G3423 CER ●	-	-	G3426 CER ●	G3427 CER	-	-		50
	115	22,23	-	-	G3423 CERTOP	-	-	G3426 CERTOP	G3427 CERTOP	-	-		50
	125	22,23	-	-	G3433 CER ●	-	-	G3436 CER ●	G3437 CER	-	-		50
	125	22,23	-	-	G3433 CERTOP	-	-	G3436 CERTOP	G3437 CERTOP	-	-		50
	180	22,23	-	-	G3453 CER ●	-	-	G3456 CER ●	G3457 CER	-	-		50
180	22,23	-	-	G3453 CERTOP	-	-	G3456 CERTOP	G3457 CERTOP	-	-		50	

**885 SERIES
(ULTRA TOP)**

The "CERAMIC TOP" (CERTOP) series fiber discs are also available in the "ULTRA TOP" (885) series that is even more performing and of higher quality.



FLEXIBLE ABRASIVES FOR FINISHING AND POLISHING

74	 <p>FINISHING PRO: FLAP DISCS: NON WOVEN+CANVAS (FOR PORTABLE ANGLE GRINDERS)</p>	
75	  <p>SHAFT-MOUNTED FLAP WHEELS: NON WOVEN, NON WOVEN+CANVAS (FOR PORTABLE STRAIGHT GRINDERS)</p>	
76	<p>ROLLS: CANVAS, NON WOVEN+CANVAS, NON WOVEN (FOR PORTABLE SATINATING MACHINES)</p>	
77	  <p>NON WOVEN PADS AND ROLLS (FOR PORTABLE POLISHING MACHINES OR MANUAL USE)</p>	
78	 <p>SCRUBBER: NON WOVEN DISCS (FOR PORTABLE ANGLE GRINDERS)</p>	
79	<p>SHINING: NON WOVEN DISCS (FOR PORTABLE ANGLE GRINDERS)</p>	
80	  <p>FLAP DISCS: NON WOVEN AND FELT WITH ABRASIVE PASTE (FOR PORTABLE ANGLE GRINDERS)</p>	
81	<p>ABRASIVE BARS AND SPONGES (MANUAL USE)</p>	

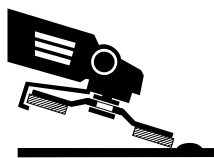

NON WOVEN+CANVAS FLAP DISCS

FOR GRINDING AND FINISHING WITH PORTABLE ANGLE GRINDERS

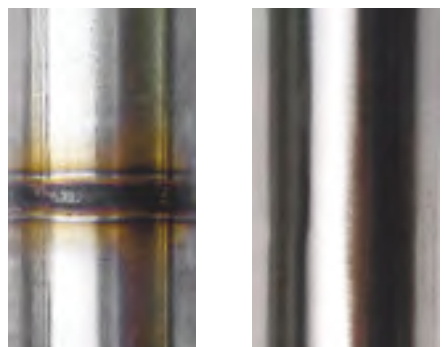

Cleaning and polishing of weldings on stainless steel tubes: before and after.



FINISHING PRO was born from the idea of creating a new generation flap disc by combining normal flaps of abrasive cloth with non woven flaps, typical of finishing discs. Abrasive cloth flaps are for "roughing" while non woven flaps (due to their fine grit) polish metal giving it a very low surface roughness and a shiny aspect. The ceramic version allows a removal speed that is at least double compared to that of corundum discs and it lasts 50% more. Suitable for quick roughing operations and for use before carrying out different finishing jobs that can be obtained with ultra coarse, coarse, medium and fine grits.



ULTRA COARSE (CERAMIC)



COARSE (CORUNDUM)



MEDIUM (CORUNDUM)



FINE (CORUNDUM)

SPEED: in order to obtain the best results, it is recommended to use discs between 3.300 and 6.000 rpm on grinding machines with adjustable speed.

WORKING PRESSURE: press the grinding machine more to obtain a quicker abrasion; lighten pressure to favour finishing.

WORKING ANGLE: to obtain the best results, always work with an angle between 5° and 10°.

RECOMMENDED APPLICATIONS:

- Light finishing of welding joints
- Round of edges
- High finishing operations
- Removal of imperfections and welding mistakes
- Preparation of surfaces
- Removal of welding drops
- Light grinding

THE ADVANTAGES OF FINISHING PRO

- Very high quality abrasive canvas
- User comfort and maximum safety
- Professional finishing
- Maximum time-saving (grinding and polishing in a single pass)
- Shiny surfaces and homogeneous finishing
- Long durability
- Excellent performance also for curved surfaces
- Materials: stainless steel, special alloys and aluminium
- No vibrations
- No metal overheating

TYPE OF ABRASIVE	DIMENSIONS (diam - bore) mm	GRIT	ART. CODE	
● CERAMIC	NEW 115x22,23	ULTRA COARSE	G6010	5pcs
	NEW 125x22,23	ULTRA COARSE	G6030	5pcs
● CORUNDUM	115x22,23	COARSE	G6011 •	5pcs
	125x22,23	COARSE	G6031	5pcs
	115x22,23	MEDIUM	G6012 •	5pcs
	125x22,23	MEDIUM	G6032 •	5pcs
	115x22,23	FINE	G6013 •	5pcs
	125x22,23	FINE	G6033 •	5pcs





SHAFT MOUNTED FLAP WHEELS, NON WOVEN AND NON WOVEN+CANVAS FOR SATIN FINISHING AND FINISHING WITH PORTABLE STRAIGHT GRINDERS

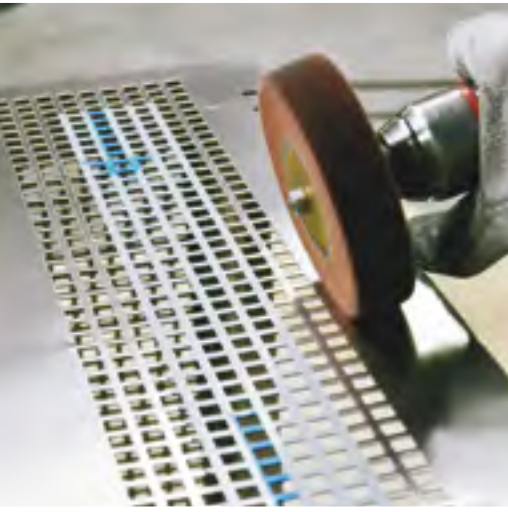

Non woven **FLAP WHEELS** and non woven+abrasive canvas with 6mm shaft.
 These latest one are similar to non woven wheels, but the addition of abrasive canvas allows a better removal and eliminates possible scratches left on the workpiece.

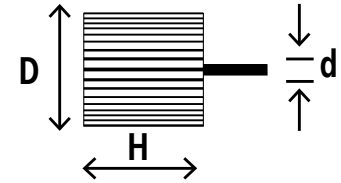

NON WOVEN

DIMENSIONS (mm)	ART. CODE	ART. CODE	ART. CODE	ART. CODE	
D x H x d	A-MEDIUM	A-FINE	A-VERY FINE	S-ULTRA FINE	pcs
30x20x6	G7521 •	G7531 •	G7541 •	G7581 •	25
40x20x6	G7523 •	G7533 •	G7543 •	G7583 •	25
60x30x6	G7625 •	G7635 •	G7645 •	G7685 •	25
80x50x6	G7722	G7732	G7742	G7782	25

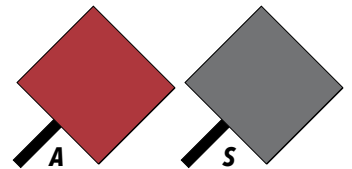

A: aluminum oxide (corundum)
 S: silicon carbide

NON WOVEN + CLOTH

DIMENSIONS (mm)	ART. CODE	ART. CODE	ART. CODE	
D x H x d	A-MEDIUM (+P 80)	A-FINE (+P 120)	A-VERY FINE (+P 240)	pcs
30x20x6	G8021 •	G8031 •	G8081 •	25
40x20x6	G8023 •	G8033 •	G8083 •	25
60x30x6	G8232 •	G8252 •	G8352 •	25
80x50x6	G8531	G8541	G8591	25

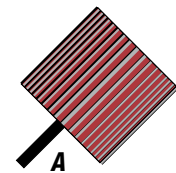

A: aluminum oxide (corundum)

All GLOBE shaft mounted flap wheels are also available in different sizes and grit, on demand.

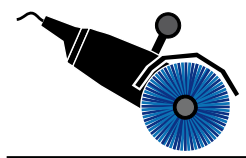

CANVAS, NON WOVEN/CANVAS AND NON WOVEN ROLLS FOR GRINDING, SATIN FINISHING AND POLISHING WITH PORTABLE MACHINES

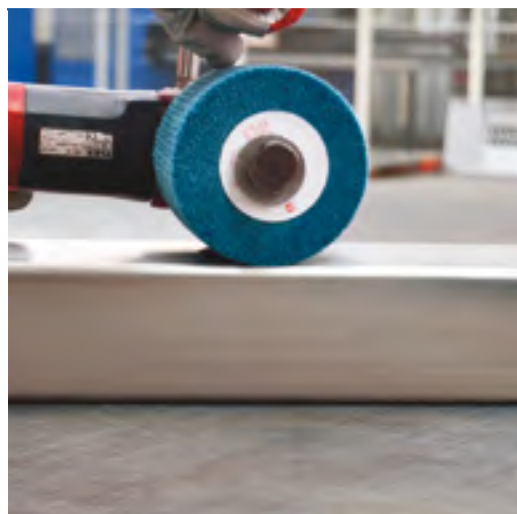

ROLLS (OR WHEELS) for satinizing machines, are among the most versatile tools for finishing any material, they allow to work on a wide area increasing processing yield.



THE ADVANTAGES OF GLOBE ROLLS

- Compact and uniform in processing
- Wide working surface
- Long durability
- Don't heat workpieces
- Anti-clogging

RECOMMENDED WORKS

- Satin finish and cleaning of metals, conventional or special stainless steel.
- Decorative finish of stainless steel, aluminium and brass.
- Removal of oxidation, grease and paint.
- Processing of aluminium alloys, non-ferrous metals, cast iron, titanium, sanding of raw and painted wood.
- Production and maintenance of machines and plants for the food, chemical, pharmaceutical and hospital industry.
- Steel and stainless steel furniture, extractor hoods, household appliances, kitchens and quality finish.
- Plastic, paint, lacquer, stucco, stone or wood.

ABRASIVE TYPE	DIMENSIONS (length-width-bore) mm	GRIT	ART. CODE	
ZIRCONIA NON WOVEN ROLLS These tools are made of non woven flaps radially glued on a central core.	100x100x19	COARSE	G6621 •	1pc
	100x100x19	MEDIUM	G6626 •	1pc
	100x100x19	FINE	G6631 •	1pc
	100x100x19	VERY FINE	G6636 •	1pc
NON WOVEN + CANVAS WITH ALTERNATED FLAPS Non woven flaps tend to satin-finish the metal on which they are used, while the canvas ones guarantee a better removal eliminating possible signs left on the workpiece.	100x100x19	A 40	G6642 •	1pc
	100x100x19	A 60	G6644 •	1pc
	100x100x19	A 80	G6645 •	1pc
	100x100x19	A 120	G6647 •	1pc
CORUNDUM ROLLS Fully made of abrasive canvas. Used on any type of metal. In the coarsest grits, they can be used also on stone, marble and fiberglass.	100x100x19	A 40	G6672 •	1pc
	100x100x19	A 60	G6674 •	1pc
	100x100x19	A 80	G6675 •	1pc
	100x100x19	A 120	G6677 •	1pc
	100x100x19	A 180	G6679 •	1pc
	100x100x19	A 240	G6681 •	1pc
	100x100x19	A 320	G6683 •	1pc

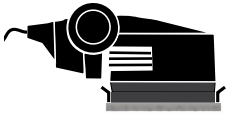

NON WOVEN BUFFING PADS AND ROLLS FOR CLEANING, SATIN FINISHING AND POLISHING



NON WOVEN PADS and **ROLLS** are used for manual processing or can be mounted on orbital or rectilinear polishers. With this type of extremely versatile product that is available in the aluminum oxide and silicon carbide versions, it is possible to work in an excellent way on a wide variety of surfaces: steel, iron, metals, wood, plastic, ceramic.

STAINLESS STEEL, STEEL AND OTHER METALS: for satin-finishing of flat surfaces, removal of oxides, preparation of details and removal of imperfections in general.

BODYWORK: to opacify paint. Thanks to the special density of material, it does not clog even with difficult surfaces such as stuccos.

WOOD: for finishing raw wood on painted base.

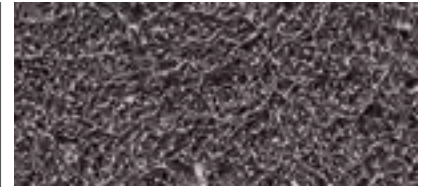

The wide weave allows the escape of the material removed, thus avoiding clogging and guarantees a quality and efficient work.

To renew the non woven fabric, it is enough to rinse it with water or blow it with air then use it again until it is completely exhausted. Unlike traditional abrasive cloths, NON WOVEN BUFFING PADS and ROLLS can be used on both sides, increasing their lifetime and economy.

THE ADVANTAGES OF NON WOVEN BUFFING PADS AND ROLLS

- Easy to use
- Do not clog
- Extremely versatile
- Adaptable to all shapes and surfaces
- Can be used both dry and with lubricants

Silicon carbide



Non woven pads 120x280mm. Pack of 10 pcs.

Aluminum oxide



Non woven roll 115mm x 10.000mm. Pack of 1 pc.



TYPE OF ABRASIVE	DIMENSIONS (width - length) mm	GRIT	ART. CODE	
● ALUMINUM OXIDE	120x280 (pads)	MEDIUM	G6415 •	10pcs
	120x280 (pads)	FINE	G6417 •	10pcs
	120x280 (pads)	VERY FINE	G6419 •	10pcs
	115x10.000 (rolls)	MEDIUM	G6515 •	1pc
	115x10.000 (rolls)	FINE	G6517 •	1pc
	115x10.000 (rolls)	VERY FINE	G6519 •	1pc
● SILICON CARBIDE	120x280 (pads)	ULTRA FINE	G6426 •	10pcs
	115x10.000 (rolls)	ULTRA FINE	G6526 •	1pc

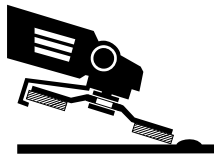

"SCRUBBER" NON WOVEN CLEANING DISC FOR PORTABLE ANGLE GRINDERS



The new **GLOBE SCRUBBER** disc was conceived for cleaning surfaces of stainless steel, steel and non ferrous metals, allowing to eliminate: paint from surfaces, different types of oxidations such as rust, calamine, limescale and concrete residues, bringing the workpiece to an excellent condition. **GLOBE "SCRUBBER"** is made of a fiberglass backing pad, on which a very resistant and flexible nylon fiber agglomerate is installed, impregnated with synthetic and abrasive resin. The extremely open structure of this product avoids clogging. Perfect for the following fields: shipbuilding construction, bodywork, carpentry.

WORKABLE MATERIALS

stainless steel and steel, aluminium, titanium, non ferrous metals, alloys, marble, granite, stones, fiberglass, plastic, wood.

MAIN USES OF GLOBE "SCRUBBER"

- Treatment of surfaces
- Cleaning of weldings without removing material
- Pickling
- Removal of paints and enamels, burrs, rust and calamine
- Removal of sediments, protective wax, concrete, salt, grease



Before and after SCRUBBER pass on a stove enamelled tube.

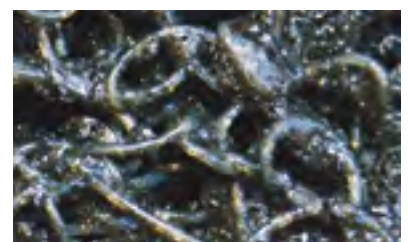
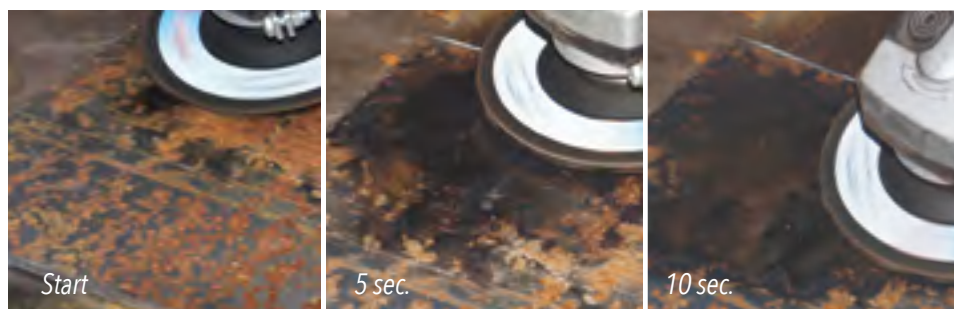

SCRUBBER: magnification of the special structure of the compound.

TYPE OF ABRASIVE	DIMENSIONS (diam - bore) mm	GRIT	ART. CODE	
NON WOVEN	115x22,23	MEDIUM (BLACK)	G6211 •	5pcs
NON WOVEN	125x22,23	MEDIUM (BLACK)	G6212 •	5pcs
NON WOVEN	115x22,23	HARD (RED)	G6221	5pcs
NON WOVEN	125x22,23	HARD (RED)	G6222	5pcs

THE ADVANTAGES OF SCRUBBER

- Quick and precise cleaning
- Does not alter geometry of the the workpiece
- Economical
- Avoids the use of traditional, toxic and corrosive chemical products
- High flexibility
- Allows the use of coolants

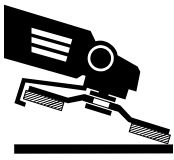

"SHINING" NON WOVEN POLISHING DISCS FOR PORTABLE GRINDERS



The GLOBE "**SHINING**" disc is part of a new generation of abrasive products for finishing. It is made of a fibreglass backing pad on which a 3D nylon material impregnated by synthetic resin and abrasive is installed. This material is simply called non woven fabric and it is perfect for a simple and versatile finishing, for preparing surfaces to painting or galvanic treatments, to reduce roughness left by previous workings with belts or abrasive discs. The secret of this disc is the surprising abrasion combined with an excellent finishing.

THE ADVANTAGES OF SHINING

- It fits to the workpiece shape
- Perfect for stainless steel: does not leave contamination or traces
- Avoids "smearing": does not leave any residue or signs on the workpiece
- Long durability and constant density
- Avoids formation of material heaps



BEFORE



AFTER

Before (L) and after (R) SHINING pass on a semifinished workpiece.



SHINING: magnification of the special structure of the compound.

MAIN USES OF SHINING

- Quick removal of pittings
- Removal of material and roundings
- Finishing of Tig and Mig/Mag weldings
- Correction of grinding errors
- Removal of imperfections without changing the workpiece geometry
- Removal of milling scratches, paints...
- Removal of paintings or coverings
- Pre-polishing
- Cleaning of turbine blades and propellers
- Improves surface roughness: useful for pharmaceutical and food industry, where special requirements have to be followed for the products' surface roughness.

TYPE OF ABRASIVE	DIMENSIONS (diam - bore) mm	GRIT	ART. CODE	
● ALUMINUM OXIDE	115x22,23	AF-MEDIUM	G6116 ●	5pcs
	115x22,23	AM-MEDIUM	G6125 ●	5pcs
	125x22,23	AF-MEDIUM	G6146 ●	5pcs
	125x22,23	AM-MEDIUM	G6155 ●	5pcs
● SILICON CARBIDE	115x22,23	SVF-SOFT	G6113 ●	5pcs
	115x22,23	SVF-MEDIUM	G6117 ●	5pcs
	125x22,23	SVF-SOFT	G6143 ●	5pcs
	125x22,23	SVF-MEDIUM	G6147 ●	5pcs

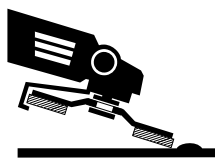

NON WOVEN AND FELT FLAP DISCS FOR **SANDING AND FINISHING** WITH PORTABLE MACHINES



NON WOVEN FLAP DISCS

	DIMENSIONS (diam - bore) mm	GRIT		ART. CODE	
NEW	115x22,23	COARSE		G6051 •	5pcs
NEW	125x22,23	COARSE		G6071	5pcs
NEW	115x22,23		MEDIUM	G6052 •	5pcs
NEW	125x22,23		MEDIUM	G6072	5pcs
NEW	115x22,23		VERY FINE	G6053 •	5pcs
NEW	125x22,23		VERY FINE	G6073	5pcs

NON WOVEN FLAP DISCS

Discs with non woven flaps for **SURFACE CONDITIONING**.

CHARACTERISTICS

This material is aggressive and long-lasting, thanks to its particularly rich structure, which does not allow cloggings.

TO BE USED

To be used for removing grinding signs and imperfections on the processed surfaces.

FELT FLAP DISC AND POLISHING PASTE

	DIMENSIONS (diam - bore) mm	PRODUCT	ART. CODE	
NEW	115x22,23	FELT DISC	G6081 •	5pcs
NEW	125x22,23	FELT DISC	G6082 •	5pcs
	DIMENSIONS (length-width-thick) mm	PRODUCT	ART. CODE	
NEW	156x52x35	POLISHING PASTE	G6083 •	4pcs

FELT FLAP DISCS: felt flap discs, fiberglass backing for mirror-polishing with abrasive paste.

TO BE USED: to be used on angle grinders at low speed (6.000 RPM recommended).



Felt disc for mirror-polishing.

SHAFT MOUNTED FELT FLAP WHEELS

	DIMENSIONS (D x H x d) mm	PRODUCT	ART. CODE	
NEW	30x30x6	FELT FLAP WHEEL	G6093	10pcs
NEW	40x30x6	FELT FLAP WHEEL	G6094	10pcs
NEW	50x30x6	FELT FLAP WHEEL	G6095	10pcs
NEW	60x30x6	FELT FLAP WHEEL	G6096	10pcs
NEW	80x30x6	FELT FLAP WHEEL	G6098	10pcs

Shaft mounted felt flap wheels for mirror-polishing with abrasive paste.

APPLICATION

To be used on straight grinders with low number of revolutions.





ABRASIVE BARS AND SPONGES MANUAL USE

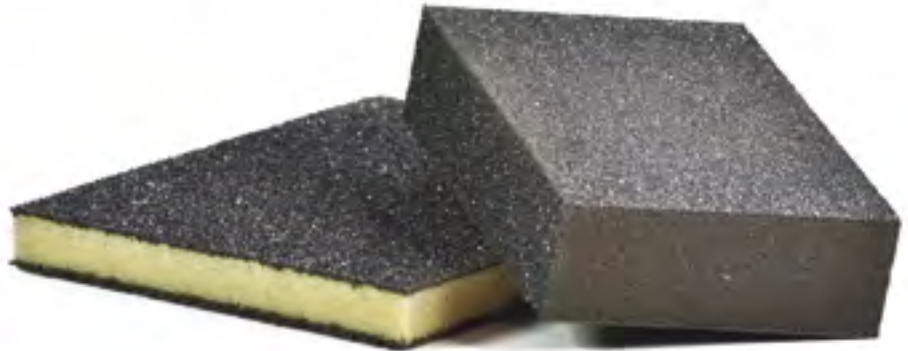

ABRASIVE BARS AND SPONGES

For dry or wet hand processing.

Main sectors of use:
BOAT INDUSTRY
CARPENTRY AND RESTORATION
BODYWORK



ABRASIVE BARS: abrasive on 4 sides.

APPLICATIONS

- bodywork and wood
- for sanding and finishing paints
- suitable for the finish sanding of edges and angles
- easy and fast to use, very versatile

SPECIFICATIONS	DIMENSIONS (length-width-thick) mm	GRIT	ART. CODE	
BARS				
NEW	98x69x26	COARSE	G6696 •	24pcs
NEW	98x69x26	MEDIUM	G6697 •	24pcs
NEW	98x69x26	FINE	G6698 •	24pcs

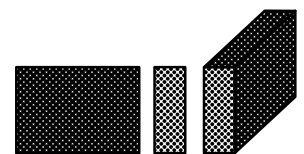

ABRASIVE SPONGES: abrasive on 2 sides.

APPLICATIONS

To use for sanding, finishing and finish sanding of:

- any type of surface (edges, corners, grooves...)
- materials like metal (bodyworks...) and wood (doors, windows, tables, chairs...)
- they adapt to the shape of the surfaces to process, and keep the flat shape on 2 sides
- can be rinsed after use

SPECIFICATIONS	DIMENSIONS (length-width-thick) mm	GRIT	ART. CODE	
SPONGES				
NEW	120x98x12	COARSE	G6691 •	32pcs
NEW	120x98x12	MEDIUM	G6692 •	32pcs
NEW	120x98x12	FINE	G6693 •	32pcs

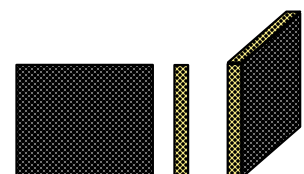



84

SEGMENTED AND CONTINUOUS RIM DIAMOND DISCS
FOR PORTABLE ANGLE GRINDERS OR
MACHINES WITH COMBUSTION ENGINE



85

DIAMOND CORE BITS AND ACCESSORIES
FOR PORTABLE AXIAL MACHINES

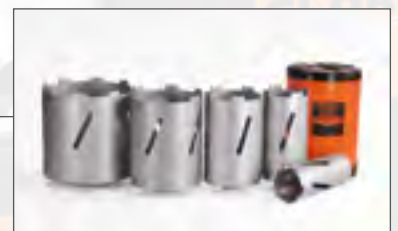

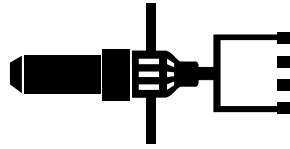
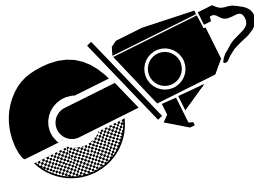

GLOBE DIAMOND LINE

GLOBE presents the new line of diamond tools: fast, precise, effective, safe, recommended for professionals. The GLOBE DIAMOND line is divided into:

- **CONTINUOUS RIM DIAMOND DISCS**
- **SEGMENTED DIAMOND DISCS**
- **DIAMOND CORE DRILL BITS**

Both types of diamond discs have the common characteristic to be universal, they can be used for:

BETON
REINFORCED CONCRETE AND NOT
GRANITES
NATURAL STONES
MARBLES
REFRACTORY MATERIALS
CERAMIC



Continuous rim discs with packaging.

CONTINUOUS RIM DIAMOND DISCS,

available in diameters 115 mm and 230 mm; can be of 3 different qualities:

- **PLUS** (top line) the best product available on the market, top of the range, perfect for professionals who make a daily use of the disc and expect long durability and fast cut. The carefully studied diamond deposition allows to have a fast and precise product for cutting operations. Ideal for heavy works, resistant to stress, ready for any type of work;

- **EVO** (standard line) intermediate level, where quality meets the right price, can satisfy any type of performance. The perfect mix between quality and price;

- **DYN** (basic line) an economical quality product, suitable for not particularly heavy works and for all users. The three different quality lines allow to have a wide range for choosing the right disc for every occasion. The specific disc for STONEWARE in diameter 115 mm is available in the PLUS quality.



Segmented diamond discs with packaging.

SEGMENTED DIAMOND DISCS,

available only in the EVO quality, the right quality-price ratio, in diameters 115 mm, 230 mm, 350 mm and 400 mm.

The PLUS quality disc, suitable for heavy works, is also available in diameter 230 mm.



Segmented rim core bits with packaging.

DIAMOND CORE DRILL BITS FOR DRY USE,

are available in the following diameters: 62mm, 82mm, 102mm, 127mm, 162mm; the length is standard for all the diamond core drill bits: 150 mm; GLOBE offers a high quality product, ready to satisfy any requirement. GLOBE Diamond Core Drill Bits are suitable to carry out round holes into BETON, REINFORCED OR UNREINFORCED CONCRETE, GRANITES, NATURAL STONE, REFRACTORY MATERIALS, SANDSTONE.

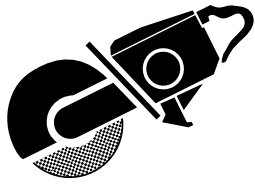

DIAMOND DISCS FOR PORTABLE ANGLE GRINDERS AND MACHINES WITH COMBUSTION ENGINE



CONTINUOUS RIM DIAMOND DISCS

MATERIAL	DIAM. (mm)	QUALITY	USE SPEED	ART. CODE	
NEW UNIVERSAL	115	PLUS	80 m/s	G7231 ●	1pc
NEW UNIVERSAL	230	PLUS	80 m/s	G7234 ●	1pc
NEW UNIVERSAL	115	EVO	80 m/s	G7221 ●	1pc
NEW UNIVERSAL	230	EVO	80 m/s	G7224 ●	1pc
NEW UNIVERSAL	115	DYN	80 m/s	G7211 ●	1pc
NEW UNIVERSAL	230	DYN	80 m/s	G7214 ●	1pc
NEW PORCELAIN STONEWARE	115	PLUS	80 m/s	G7231 GRES ●	1pc



SEGMENTED DISCS

MATERIAL	DIAM. (mm)	QUALITY	USE SPEED	ART. CODE	
NEW UNIVERSAL	115	EVO	80 m/s	G7251 ●	1pc
NEW UNIVERSAL	230	EVO	80 m/s	G7254 ●	1pc
NEW UNIVERSAL	350	EVO	80 m/s	G7257 ●	1pc
NEW UNIVERSAL	400	EVO	80 m/s	G7258 ●	1pc
NEW UNIVERSAL	230	PLUS	80 m/s	G7254 TOP ●	1pc



Table for choosing the right disc according to the intended use.

QUALITY:	◆◆◆ PLUS			◆◆ EVOLUTION		◆ DYNAMIC
	CONTINUOUS	CONTINUOUS	SEGMENTED	CONTINUOUS	SEGMENTED	CONTINUOUS
CROWN TYPE:	CONTINUOUS	CONTINUOUS	SEGMENTED	CONTINUOUS	SEGMENTED	CONTINUOUS
SPECIFICATIONS:	UNIVERSAL PROFESSIONAL. RESISTANT RELIABLE.	STONEWARE: SPECIFIC FOR STONEWARE. ALSO FOR TILES	TOP: UNIVERSAL PROFESSIONAL. RESISTANT RELIABLE.	FOR CUTTING ALL BUILDING MATERIALS.	REINFORCED CONCRETE.	FOR NON CONTINUOUS USE.
CUTTING SPEED:	●●●●○	●●●●●	●●●●○	●●●○○	●●●○○	●●○○○
DURABILITY:	●●●●○	●●●○○	●●●●●	●●●○○	●●●○○	●●○○○
MATERIALS:	SANDSTONE PLATES	●●●○○	○○○○○	●●●○○	●○○○○	●○○○○
	LITTLE REINFORCED CONCRETE	●●●●●	○○○○○	●●●●●	●●●●●	●●●○○
	VERY REINFORCED CONCRETE	●●●●○	○○○○○	●●●●●	●○○○○	●○○○○
	CONCRETE-BRICKS-TILES	●●●●○	○○○○○	●●●●●	●●●●○	●●●○○
	DOUBLE-FIRING CERAMIC	●○○○○	●●●●●	●○○○○	●○○○○	●○○○○
	SINGLE-FIRING CERAMIC	●●○○○	●●●●●	●○○○○	●○○○○	●○○○○
	GRANITE-STONES-PORPHYRIES	●●●●●	●●●○○	●●●○○	●●●○○	●○○○○
	STONEWARE-KLINKER	●●●○○	●●●●●	●○○○○	●○○○○	●○○○○
	MARBLES	●○○○○	●●●●●	●○○○○	●○○○○	○○○○○
	REFRACTORY MATERIALS	●●●○○	○○○○○	●●●○○	●○○○○	●○○○○

● = articles always in stock

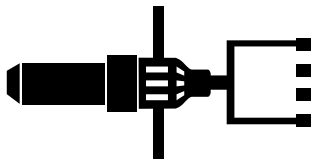

DIAMOND CORE DRILL BITS FOR PORTABLE DRILLING MACHINES AND ACCESSORIES



SEGMENTED DIAMOND CORE DRILL BITS

	MATERIAL	DIMENSIONS (diam-length) mm	DESCRIPTIONS	USE SPEED	ART. CODE	
NEW	UNIVERSAL	62x150	DIAMOND CORE DRILL BITS for dry use	80 m/s	G7311 •	1pc
NEW	UNIVERSAL	82x150	DIAMOND CORE DRILL BITS for dry use	80 m/s	G7321 •	1pc
NEW	UNIVERSAL	102x150	DIAMOND CORE DRILL BITS for dry use	80 m/s	G7331 •	1pc
NEW	UNIVERSAL	127x150	DIAMOND CORE DRILL BITS for dry use	80 m/s	G7341 •	1pc
NEW	UNIVERSAL	162x150	DIAMOND CORE DRILL BITS for dry use	80 m/s	G7351 •	1pc

ACCESSORIES FOR DRY CORING



CYLINDRICAL CENTRING DRILLS:

220 mm long for core bits 150 mm long, 270 mm long for core bits 200 mm long, to be used together with the hexagonal, sds and sds max fittings.



SDS CENTRING DRILLS:

230 mm long for core bits 150 mm long, 260 mm long for core bits 200 mm long, to be used together with the quick adapters.



HEXAGONAL FITTINGS:

available in various lengths, to be used when dry core bits are used with an M16 fitting on manual drilling machines with rack spindle.



SDS FITTINGS:

available in various lengths, to be used when dry core bits are used with an M16 fitting on manual drilling machines or anchor bolt inserters with spindle with sds-plus coupling.



SDS MAX FITTINGS:

only available in the 300 mm length, to be used when dry M16 core bits are used on hammers or anchor bolt inserters with spindle with sds-max coupling. Only use it with core bit diameters greater than 127 mm.



EXTENSIONS:

available in various lengths and with various threads, they make it possible to drill in depth.



QUICK ADAPTERS:

they allow mounting and demounting of the centring drill from the adapter with a click. Available for the majority of manual drilling machines on sale. To use with the Sds centring drill.



ADAPTERS:

comprehensive range of adapters is available for assembling the various core bits on the majority of drilling machines on sale.

87 **MINI DISCS FULL KIT FOR COMPRESSED AIR MACHINES**

COMPLETE RANGE OF PRECISION DISCS FOR CUTTING, GRINDING AND FINISHING (Ø 50 TO 75mm)



89 **STEEL & BRASS BRUSHES (FOR STRAIGHT MACHINES AND MANUAL USE)**
WHITE HAND-CLEANING PASTE (WITHOUT MICROPLASTICS)



90 **TUNGSTEN CARBIDE ROTARY BURRS**
(FOR PORTABLE STRAIGHT GRINDERS OR DRILL)



98 **ECO-FRIENDLY CLEANERS FOR METALS**
UNIVERSAL CLEANERS: **CLEANER**
CONCENTRATED CLEANERS: **HV CLEANER, INOX CLEANER**
STAINLESS STEEL FINISHING AND PROTECTION: **SHINOX**



99 **WELDING PRODUCTS**
ANTI-SPATTER GEL FOR NOZZLES: **WELD DYN**
ANTI-SPATTER SPRAY: **WELD EVO**
ANTI-SPATTER AEROSOL: **WELD PLUS**



100 **ACCESSORIES**

BACKING PADS WITH CLAMPING FLANGE FOR FIBER DISCS
CLAMPING FLANGE FOR FIBER DISCS



PLASTIC SPACERS FOR ABRASIVE DISCS
STEEL FLANGES AND DAMPING FLANGES DISCS
STEEL SPACERS (3 THICKNESSES AVAILABLE)



ADAPTOR RINGS FOR BIG DIAMETER CUTTING DISCS
REDUCTION PIVOTS FOR STRAIGHT GRINDERS



101 **PROFESSIONAL GLOVES AND WELDER APRON**



102 **PACKAGING AND DISPLAYS**
COUNTER DISPLAYS (STEADY AND ROTATING)
FLOOR DISPLAY
PATENTED PACKAGING



KIT

MINI DISCS FULL KIT FOR COMPRESSED AIR MACHINES



A complete range of mini-discs (Ø 50 to 75mm) for cutting, grinding and finishing of:
IRON, STAINLESS STEEL, CAST IRON, NON-FERROUS METALS (ALUMINIUM, BRONZE, COPPER) FIBER-GLASS, WOOD, CERAMIC, STONE AND MARBLE.
Ideal for cutting, grinding and polishing in tight spaces and on complex parts. Especially suitable for high precision works thanks to its extreme handling and practicality of use. Maximum safety!



SAFECUT and ZIP HP

Unequaled cutting tools, very thin, able to perform precision cuts in any position. Unbelievable durability and performances.

TURBOTWISTER

We are the only manufacturers in the world of this semi-flexible grinding wheel. Extremely versatile and effective, aggressive also on aluminium and fiberglass. Suitable for scraping, fast grinding and at the same time excellent finishing. It adapts very well to concave surfaces, inside turbine blades etc...

FLAP DISCS

To be used in light grinding and finishing operations. Excellent for finishing welds in corners.

FIBER DISCS

Available in various grain sizes, for light removal and finishing operations at any level.

SCOTCH-BRITE

Suitable for paint stripping, light grinding and polishing. Grit sizes suitable for any finishing grade.

BLACK CLEANER

Soft disk, made of a nylon yarn weave with abrasive granules.

Extremely versatile tool, able to remove paint, scrape, remove metal, wood, aluminium, etc. and to bring the worked piece to a medium-high finishing degree.

DESCRIPTION	ASSEMBLING/BORE	ART. CODE	
PNEUMATIC ANGLE GRINDER Ø75 mm	PIVOT 1/4 WHITW.	G5001	1pc
SAFETY GUARD FOR PNEUMATIC GRINDER Ø 75 mm	-	G5003	1pc
PIVOT FOR BORE 9,53 mm	1/4 WHITW. FEMALE 1/4 WHITW. FEMALE	G5004	1pc
PIVOT FOR BORE 9,53 mm	1/4 WHITW. MALE	G5005	1pc
PIVOT FOR BACKING PAD ASSEMBLING	1/4 WHITW. FEMALE 5/16" MALE	G5006	1pc
BACKING PAD Ø50 mm	5/16" FEMALE ROLON FEMALE	G5008	1pc
BACKING PAD Ø75 mm	5/16" FEMALE ROLON FEMALE	G5009	1pc
WRENCH - 17 mm	-	G5011	1pc
SOCKET WRENCH - 13 mm	-	G5013	1pc
WRENCH FOR PIVOT 1/4 WHITWORTH - 11 mm	INCLUDED	G5015	-
GRINDING WHEEL TURBOTWISTER Ø75 mm GRIT 36	BORE 9,53 mm	G0825	50pcs
GRINDING WHEEL TURBOTWISTER Ø75 mm GRIT 60	BORE 9,53 mm	G0835	50pcs
DC THIN CUTTING DISC SAFECUT HP (75x1,0x9,53) A60S	BORE 9,53 mm	G1537	50pcs
DC THIN CUTTING DISC SAFECUT HP (75x1,0x9,53) A60SX	BORE 9,53 mm	G1547	50pcs
FLAT THIN CUTTING DISC ZIP HP (75x1,3x9,53) A60SX	BORE 9,53 mm	G1622 •	100pcs
FLAT THIN CUTTING DISC ZIP HP (75x1,0x9,53) A60SX	BORE 9,53 mm	G1622-1	100pcs
REINFORCED FLAT CUTTING DISC (75x4,0x9,53) A-QX	BORE 9,53 mm	G1812 9,5	100pcs
FLAT CUTTING DISC ZIP HP TYPE (50x1,0x9,53) A60S	BORE 9,53 mm	G1621-1	100pcs
FLAT CUTTING DISC ZIP HP TYPE (50x1,0x9,53) A60SX	BORE 9,53 mm	G1621-2	100pcs
REINFORCED FLAT WHEEL (50x4,0x9,53) A-QX	BORE 9,53 mm	G1811 9,5	100pcs
FLAP DISC Ø50 mm Z 40	ROLON	G2954 •	10pcs
FLAP DISC Ø50 mm Z 80	ROLON	G2958 •	10pcs
FLAP DISC Ø75 mm Z 40	ROLON	G2974	10pcs
FLAP DISC Ø75 mm Z 80	ROLON	G2978	10pcs
TNT DISC Ø50 mm MEDIUM (RED)	ROLON	G5212 •	25pcs
TNT DISC Ø50 mm VERY FINE (GREY)	ROLON	G5214 •	25pcs
TNT DISC Ø75 mm MEDIUM (RED)	ROLON	G5312 •	25pcs
TNT DISC Ø75 mm VERY FINE (GREY)	ROLON	G5314 •	25pcs
TNT DISC BLACK CLEANER Ø50 mm - THICK. 14 mm	ROLON	G5650 •	25pcs
TNT DISC BLACK CLEANER Ø75 mm - THICK. 14 mm	ROLON	G5675 •	25pcs
ABRASIVE CLOTH DISC Ø50 mm GR. 60 AO (GREY)	ROLON	G5812 •	50pcs
ABRASIVE CLOTH DISC Ø50 mm GR. 120 AO (RED)	ROLON	G5815 •	50pcs
ABRASIVE CLOTH DISC Ø 75 mm GR. 60 AO (GREY)	ROLON	G5912 •	50pcs
ABRASIVE CLOTH DISC Ø 75 mm GR. 120 AO (RED)	ROLON	G5915 •	50pcs



Thin cutting disc Safecut DC:
75x1,0x9,53 A60SX



Thin cutting disc ZIP HP:
75x1,0x9,53 A60SX



TurboTwister:
Ø75 mm, GRIT 36



Flap disc:
Ø75 mm, GRIT 40



• = articles always in stock

STEEL AND BRASS BRUSHES FOR STRAIGHT MACHINES AND MANUAL USE



STEEL AND BRASS BRUSHES

Used for manual works both dry and wet. Brushes with high-strength steel and brass wire. Brushes with a corrugated line and at short bundles. Strong and aggressive brushes. Maximum safety of use.

SHAPE	SPECIFICATIONS					ART CODE	
	(D)	(F)	(bundles n.)	(s)	(Ø of the line)		
CZ95 CONICAL	95	M14	18	20mm	0,50mm/s. steel	G7133 •	1pc
CO90 CONICAL	90	M14	-	20mm	0,35mm/s. steel	G7153 •	1pc
TZ70 CUP	75	M14	18	17mm	0,35mm/s. steel	G7143 •	1pc
T80 CUP	80	M14	-	25mm	0,35mm/s. steel	G7113 •	1pc

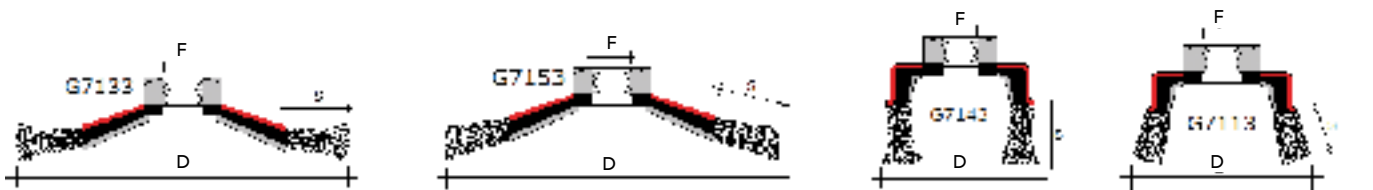

SHAPE	SPECIFICATIONS				ART. CODE	
	(D)	(L)	(s)	(Ø of the line)		
MANUAL BRUSH	280mm	130mm	28mm	0,30mm/brass	G7103 •	1pc

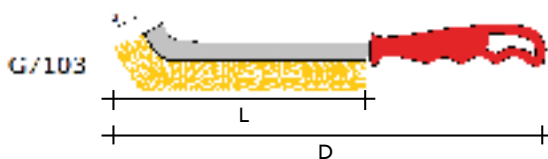

HAND CLEANING PASTE

NEW	PRODUCT	PACKAGING	ART. CODE	
		WHITE HAND CLEANING PASTE (WITHOUT MICROPLASTICS)	JAR 4kg	GC0201 •





TUNGSTEN CARBIDE ROTARY BURRS FOR PORTABLE STRAIGHT GRINDERS OR DRILLS

TUNGSTEN CARBIDE ROTARY BURRS

		FRONT CUT			
Type	ZYA	ZYA-S	WRC	SPG	WKN
Type ISO	A	A-S	C	G	N
Ø mm	2-20	2-20	3-20	3-16	3-12

CUTTING PROFILE

1A Aluminium	●	●	●	●	
1 DIN C			●		
2	●	●	●	●	
3 DIN MY	●	●	●	●	●
4 Diamond	●	●	●	●	
6 DIN MX	●	●	●	●	●

DESCRIPTION OF CUTS

<p>Cut 1A (aluminium): Suitable for aluminium and aluminium alloys as well as plastics.</p>	<p>Cut 1 (DIN C): Suitable for deburring non-hardened steels, soft steels, alloys and hard plastics.</p>	<p>Cut 2: Suitable for steels with high tensile strength, inox, cast steels, welding seams and brass</p>



TUNGSTEN CARBIDE ROTARY BURRS

							
SKM	KSK	KSJ	TRE	KUD	RBF	KEL	B
M	K	J	E	D	F	L	H
3-16	3-20	3-16	3-16	2,5-20	3-20	3-16	6-16

CUTTING PROFILE

				●	●	●	
					●	●	
●				●	●	●	
●	●	●	●	●	●	●	●
●			●	●	●	●	●
●	●	●	●	●	●	●	●

DESCRIPTION OF CUTS

		
<p>Cut 3 (DIN MY): For general purposes such as deburring, chamfering and smoothing edges with clean surface. Suitable for steels with high tensile strength and welding seams.</p>	<p>Cut 4 (diamond): Suitable for hardened steels with excellent surface quality and welding seams with high tensile strength.</p>	<p>Cut 6 (DIN MX): With this universal cutting profile even hardest materials and welding seams can be machined with best finishing quality. Ideal for the tool and mould industry.</p>

● = available in 20 days

▼ = articles always in stock

CUTTING PROFILES



Aluminium



2



4

Diamond



DIN C



3

DIN MY



6

DIN MX

More detailed information about the different cutting profiles: page 86



TUNGSTEN CARBIDE
ROTARY BURRS:
CYLINDRICAL,
WITHOUT FRONT CUT.

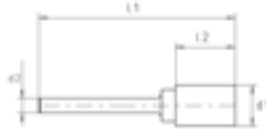

d1 mm	l2 mm	d2 mm	l1 mm	1A ART. CODE	1 ART. CODE	2 ART. CODE	3 ART. CODE	4 ART. CODE	6 ART. CODE	
2	10	3	38	●		●	●	●	●	1pc
2,5	12	3	38	●		●	●	●	●	1pc
3	14	3	38	●		●	●	●	●	1pc
3	14	3	50	●		●	●	●	●	1pc
3	14	3	65	●		●	●	●	●	1pc
4	10	3	40	●		●	●	●	●	1pc
4	14	6	50	●		●	●	●	●	1pc
5	12	3	42	●		●	●	●	●	1pc
6	13	3	43	●		●	●	●	●	1pc
6	16	6	50	●		●	G481063	●	G481066	1pc
8	20	6	65	●		●	G481083	●	G481086	1pc
10	13	6	58	●		●	●	●	●	1pc
10	20	6	65	●		●	G481103	●	G481106	1pc
12	25	6	70	G481121A		●	G481123	G481124	G481126	1pc
12	25	8	70	●		●	●	●	●	1pc
16	25	6	70	●		●	●	●	●	1pc
16	25	8	70	●		●	●	●	●	1pc
20	25	6	70	●		●	●	●	●	1pc



TUNGSTEN CARBIDE
ROTARY BURRS:
CYLINDRICAL,
WITH FRONT CUT.

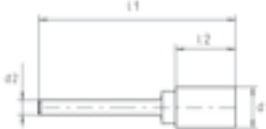

d1 mm	l2 mm	d2 mm	l1 mm	1A ART. CODE	1 ART. CODE	2 ART. CODE	3 ART. CODE	4 ART. CODE	6 ART. CODE	
2	10	3	38	●		●	●	●	●	1pc
2	10	3	50	●		●	●	●	●	1pc
2,5	12	3	38	●		●	●	●	●	1pc
2,5	12	3	65	●		●	●	●	●	1pc
2,5	12	3	75	●		●	●	●	●	1pc
3	14	3	38	●		●	●	●	●	1pc
3	14	3	50	●		●	●	●	●	1pc
3	14	3	75	●		●	●	●	●	1pc
4	14	6	50	●		●	●	●	●	1pc
6	13	3	43	●		●	●	●	●	1pc
6	16	6	50	●		G482062	G482063	●	G482066	1pc
8	20	6	65	●		●	G482083	●	G482086	1pc
10	13	6	58	●		●	●	●	●	1pc
10	20	6	65	G482101A		●	G482103	●	G482106	1pc
12	25	6	70	G482121A		●	G482123	G482124	G482126	1pc
16	25	6	70	●		●	●	●	G482166	1pc
16	25	8	70	●		●	●	●	●	1pc
20	25	8	70	●		●	●	●	●	1pc

CUTTING PROFILES



Aluminium

DIN C



DIN MY

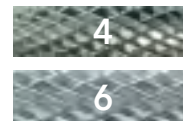

Diamond

DIN MX

More detailed information about the different cutting profiles: page 86



**TUNGSTEN CARBIDE
ROTARY BURRS:
BALL NOSE.**

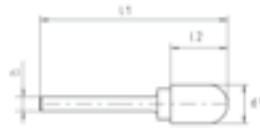

d1 mm	l2 mm	d2 mm	l1 mm	1A ART. CODE	1 ART. CODE	2 ART. CODE	3 ART. CODE	4 ART. CODE	6 ART. CODE	
3	14	3	38	●	●	●	●	●	●	1pc
3	14	3	50	●	●	●	●	●	●	1pc
4	10	3	40	●	●	●	●	●	●	1pc
4	14	6	50	●	●	●	●	●	●	1pc
5	12	3	42	●	●	●	●	●	●	1pc
6	14	3	43	●	●	●	●	●	●	1pc
6	16	6	50	●	●	●	G483063	●	G483066	1pc
6	16	6	150	●	●	●	●	●	●	1pc
8	20	6	65	●	●	●	G483083	●	G483086	1pc
10	20	6	65	●	●	●	G483103	●	G483106	1pc
10	25	6	70	G483101A	●	●	●	G483104	●	1pc
10	20	6	150	●	●	●	●	●	●	1pc
12	25	6	70	G483121A	●	●	G483123	G483124	G483126	1pc
12	25	6	150	●	●	●	●	●	●	1pc
12	25	8	70	●	●	●	●	●	●	1pc
16	25	6	70	●	●	●	●	●	●	1pc
16	25	8	70	●	●	●	●	●	●	1pc
20	25	6	70	●	●	●	●	●	●	1pc



**TUNGSTEN CARBIDE
ROTARY BURRS:
ARC POINTED
NOSE.**



d1 mm	l2 mm	d2 mm	l1 mm	1A ART. CODE	1 ART. CODE	2 ART. CODE	3 ART. CODE	4 ART. CODE	6 ART. CODE	
3	12	3	38	●	●	●	●	●	●	1pc
4	10	3	40	●	●	●	●	●	●	1pc
4	14	6	50	●	●	●	●	●	●	1pc
5	12	3	42	●	●	●	●	●	●	1pc
6	13	3	43	●	●	●	●	●	●	1pc
6	16	6	50	●	●	●	G489063	G489064	●	1pc
8	20	6	65	●	●	●	●	●	●	1pc
10	20	6	65	●	●	●	●	G489104	●	1pc
12	25	6	70	G489121A	●	●	●	G489124	G489126	1pc
12	25	8	70	●	●	●	●	●	●	1pc
16	30	6	75	●	●	●	●	●	G489166	1pc
16	30	8	75	●	●	●	●	●	●	1pc

CUTTING PROFILES



More detailed information about the different cutting profiles: page 86



TUNGSTEN CARBIDE
ROTARY BURRS:
INVERTED CONE,
WITHOUT FRONT CUT

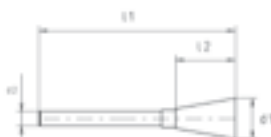

d1 mm	l2 mm	d2 mm	l1 mm	1A ART. CODE	1 ART. CODE	2 ART. CODE	3 ART. CODE	4 ART. CODE	6 ART. CODE	
3	3	3	38				●		●	1pc
6	6	3	36				●		●	1pc
8	8	6	53				G4811083		●	1pc
10	10	6	55				●		●	1pc
12	12	6	57				●		●	1pc



TUNGSTEN CARBIDE
ROTARY BURRS:
CONICAL POINTED NOSE

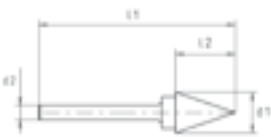

d1 mm	l2 mm	d2 mm	l1 mm	1A ART. CODE	1 ART. CODE	2 ART. CODE	3 ART. CODE	4 ART. CODE	6 ART. CODE	
3	12	3	38			●	●	●	●	1pc
3	12	3	50			●	●	●	●	1pc
4	10	3	40			●	●	●	●	1pc
6	13	3	43			●	●	●	●	1pc
6	16	6	50			●	G4810063	●	●	1pc
8	18	6	63			●	●	●	●	1pc
10	20	6	66			●	●	●	G4810106	1pc
12	25	6	70			●	G4810123	G4810124	●	1pc
16	25	6	70			●	●	●	●	1pc



TUNGSTEN CARBIDE
ROTARY BURRS:
CONE 90°.

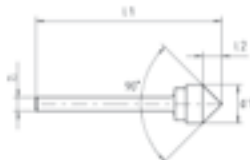

d1 mm	l2 mm	d2 mm	l1 mm	1A ART. CODE	1 ART. CODE	2 ART. CODE	3 ART. CODE	4 ART. CODE	6 ART. CODE	
3	2	3	38				●		●	1pc
4	3	6	50				●		●	1pc
5	4	3	34				●		●	1pc
6	5	6	50				●		●	1pc
8	8	6	53				●		●	1pc
10	10	6	55				G486103		●	1pc
12	12	6	57				●		●	1pc
16	16	6	61				●		●	1pc
20	20	6	65				●		●	1pc

CUTTING PROFILES



More detailed information about the different cutting profiles: page 86



**TUNGSTEN CARBIDE
ROTARY BURRS:
CONE 60°.**

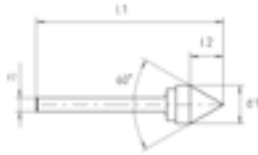

d1 mm	l2 mm	d2 mm	l1 mm	1A ART. CODE	1 ART. CODE	2 ART. CODE	3 ART. CODE	4 ART. CODE	6 ART. CODE	
3	3	3	38				●		●	1pc
4	4	6	50				●		●	1pc
6	6	6	50				●		●	1pc
10	10	6	55				●		●	1pc
12	12	6	57				●		●	1pc
16	16	6	61				●		●	1pc



**TUNGSTEN CARBIDE
ROTARY BURRS:
OVAL.**

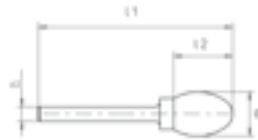

d1 mm	l2 mm	d2 mm	l1 mm	1A ART. CODE	1 ART. CODE	2 ART. CODE	3 ART. CODE	4 ART. CODE	6 ART. CODE	
3	6	3	38				●	●	●	1pc
4	6	3	36				●	●	●	1pc
4	6	6	50				●	●	●	1pc
6	10	3	40				●	●	●	1pc
6	10	6	50				G484063	●	G484066	1pc
8	13	6	58				G484083	●	G484086	1pc
10	16	6	61				G484103	●	G484106	1pc
12	20	6	65				G484123	G484124	G484126	1pc
16	25	6	70				●	G484164	●	1pc



● = available in 20 days

▼ = articles always in stock

CUTTING PROFILES



More detailed information about the different cutting profiles: page 86



TUNGSTEN CARBIDE
ROTARY BURRS:
SPHERICAL.

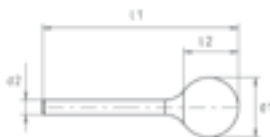

d1 mm	l2 mm	d2 mm	l1 mm	1A ART. CODE	1 ART. CODE	2 ART. CODE	3 ART. CODE	4 ART. CODE	6 ART. CODE	
2,5	2	3	38	●		●	●	●	G485026	1pc
3	2,5	3	38	●		●	●	●	●	1pc
4	3	3	33	●		●	●	●	●	1pc
4	3	6	50	●		●	●	●	●	1pc
5	4	3	34	●		●	●	●	●	1pc
6	5	3	35	●		●	●	●	●	1pc
6	5	6	50	●		●	G485063	●	G485066	1pc
8	7	6	52	●		●	G485083	●	G485086	1pc
10	9	6	54	●		●	G485103	●	G485106	1pc
10	9	6	150	●		●	●	●	●	1pc
12	10	6	55	●		●	G485123	●	G485126	1pc
12	10	6	150	●		●	●	●	●	1pc
16	14	6	59	●		●	●	●	●	1pc
16	14	8	59	●		●	●	●	●	1pc
20	18	6	63	●		●	●	●	●	1pc



TUNGSTEN CARBIDE
ROTARY BURRS:
ARC ROUND NOSE.



d1 mm	l2 mm	d2 mm	l1 mm	1A ART. CODE	1 ART. CODE	2 ART. CODE	3 ART. CODE	4 ART. CODE	6 ART. CODE	
3	12	3	38	●	●	●	●	●	●	1pc
4	10	3	40	●	●	●	●	●	●	1pc
6	13	3	43	●	●	●	●	●	●	1pc
6	18	6	50	●	●	●	●	●	●	1pc
6	13	6	150	●	●	●	●	●	●	1pc
8	18	6	63	●	●	●	●	●	●	1pc
10	20	6	65	●	●	●	●	G488104	●	1pc
10	20	6	15	●	●	●	●	●	●	1pc
12	25	6	70	G488121 A	●	●	●	G488124	G488126	1pc
12	25	6	150	●	●	●	●	G488124 L	●	1pc
12	25	8	70	●	●	●	●	●	●	1pc
16	30	6	75	●	●	●	●	●	G488166	1pc
16	30	8	75	●	●	●	●	●	●	1pc
20	30	6	75	●	●	●	●	●	●	1pc

CUTTING PROFILES

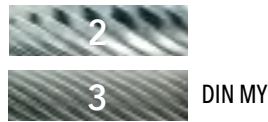
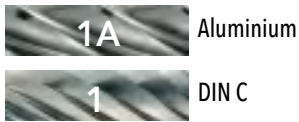

More detailed information about the different cutting profiles: page 86



**TUNGSTEN CARBIDE
ROTARY BURRS:
CONICAL ROUND NOSE.**

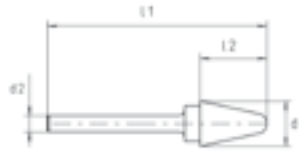

				1A	1	2	3	4	6	
				ART. CODE	ART. CODE	ART. CODE	ART. CODE	ART. CODE	ART. CODE	
d1 mm	l2 mm	d2 mm	l1 mm							
3	14	3	38	●	●	●	●	●	●	1pc
4	14	3	44	●	●	●	●	●	●	1pc
4	16	6	50	●	●	●	●	●	●	1pc
6	18	3	48	●	●	●	●	●	●	1pc
6	20	6	50	●	●	●	●	●	●	1pc
8	20	6	65	●	●	●	●	●	●	1pc
10	20	6	65	G487121 A	●	●	G487103	●	●	1pc
12	25	6	70	●	●	●	●	●	G487126	1pc
12	25	6	75	●	●	●	●	●	●	1pc
16	30	8	75	●	●	●	●	●	●	1pc



**TUNGSTEN CARBIDE
ROTARY BURRS:
FLAME.**



				1A	1	2	3	4	6	
				ART. CODE	ART. CODE	ART. CODE	ART. CODE	ART. CODE	ART. CODE	
d1 mm	l2 mm	d2 mm	l1 mm							
6	20	6	57				●	●	●	1pc
8	20	6	65				●	●	●	1pc
10	25	6	70				●	●	●	1pc
12	30	6	75				●	●	G4811124	1pc
16	30	6	77				●	●	●	1pc



CLEANERS FOR DEGREASING CLEANING AND POLISHING



GLOBE "CLEANERS": COMPLETE RANGE OF ECOLOGICAL PRODUCTS TO CLEAN, DEGREASE AND POLISH.

Cleaning, degreasing and polishing products for metal surfaces. The common feature of these cleaning products is their nature: ECOLOGICAL and WITH A VERY LOW ENVIRONMENTAL IMPACT.

THE GLOBE RANGE OF ECO-FRIENDLY LIQUID OR CREAMY CLEANERS

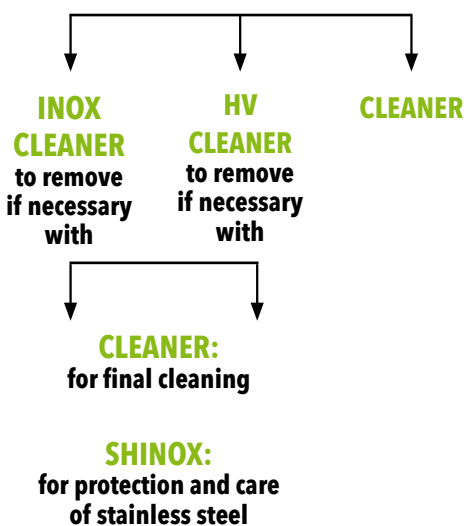

CLEANER

Universal product containing natural solvents, for cleaning surfaces from grease and oil. Can be used for the final cleaning of a workpiece or for the cleaning of the part of a piece to be welded. It does not leave any residues. It is the ideal ecological alternative to NITRO thinner, with the following advantages: no smell, more comfort in use, same cleaning efficiency, non-flammable, environmental-friendly. Spray and remove with a cloth or paper. The more product is used, the better the result. It is very important to let it act for a few minutes before removing it.

INOX CLEANER

Especially conceived for cleaning stainless steel, to be used on very dirty surfaces, corruptions, encrustation and rust from contact with a rusty piece. Waterbased product, with an internal micrograin of aluminum oxide (corundum) combined with citric acid (one of the most common acids in vegetable organisms) and phosphoric acid (used in the food industry as an acidity regulator and in dental industry to produce toothpastes for teeth whitening). The abrasive action of corundum micrograin and acid, makes it very similar to an abrasive paste. To get a more accurate cleaning, use the special manual pad (see picture above). Once treated with INOX CLEANER, clean the piece with CLEANER or rinse with water.

HV CLEANER

Highly concentrated product, with the same consistency of a liquid soap (HV = High Viscosity), for cleaning very dirty surfaces. Useful to remove oils, grease, wax, fresh paint. Depending on the dirt to be removed, you can decide whether to dilute with water or not. The more dirty the material, the more concentrated the product should be. Being an oily product, it needs to be removed with a degreaser such as CLEANER. Spray and remove with cloth or paper. The more product is used, the better the result. It is very important to let it act for a few minutes before removing it.

SHINOX

This product was especially conceived for the treatment and care of stainless steel. It is a water-based product to be sprayed on the piece after cleaning. It removes any residues, degreases and leaves a protective, dry and shiny film. Its priority is to make the piece shiny and protect it. Spray and remove with a cloth or paper. The more product is used, the better the result. It is very important to let it act for a few minutes before removing it.

	NAME	PACKING	TYPE OF PRODUCT AND USE	ART. CODE	
NEW	CLEANER	BOTTLE	UNIVERSAL CLEANER	GC0110 •	4pcs
NEW	INOX CLEANER	BOTTLE	LIQUID SOAP FOR STAINLESS STEEL	GC0120 •	4pcs
NEW	HV CLEANER	BOTTLE	CONCENTRATED CLEANER	GC0130 •	4pcs
NEW	SHINOX	BOTTLE	PROTECTIVE POLISHING CLEANER	GC0140 •	4pcs

• = articles always in stock

WELDING ANTI-SPATTER PRODUCTS



WELD: GLOBE PRODUCT RANGE FOR WELDING SUPPORT

3 products connected to the world of welding, working as ANTI-SPATTERS: they prevent weld spatters from sticking to the torch nozzle or to the surrounding areas of the piece to be welded. Having the same purpose, each one is characterized by its own special features.

NAME	PACKING	TYPE OF PRODUCT AND USE	ART. CODE	
NEW WELD DYN	TIN	Anti-spatter gel for nozzles (torch dipping)	GC0010 •	8pcs
NEW WELD EVO	BOTTLE	Anti-spatter spray (around the surface to be welded)	GC0020 •	4pcs
NEW WELD PLUS	SPRAY	Anti-spatter aerosol (to spray into the torch)	GC0030 •	6pcs



WELD DYN

Gel similar to grease/vaseline. Dip a few centimeters the hot welding torch into the grease (contained in the tin can) that drips and goes into the nozzle. It creates a protective film preventing weld spatters from sticking to the nozzle. Its effect lasts a few minutes. The can has a magnetic pad allowing to stick it to metal surfaces (also vertically) thus avoiding that it remains attached to the torch when taking it out of the grease.



WELD EVO

Spray suitable both for stainless steel and carbon steel. Spray it on the surrounding area of the piece to be welded to prevent welding beads from sticking to the metal piece. As its action lasts a few seconds, it is recommended to use it frequently. It can also be used on the torch nozzle, preventing its obstruction. After use, remove it from the surface with GLOBE "CLEANER".



WELD PLUS

Aerosol to spray on the welding torch. It creates a white protective ceramic surface preventing the accumulation of welding spatters on the nozzle. Its effect lasts some hours. Its non-stick effect is given by the white layer that avoids the direct contact between weld spatters and the metal of the nozzle. WELD PLUS has an excellent performance, very appreciated by professional welders.

BRUSHES - ROTARY BURRS - CLEANERS FOR METALS - WELDING PRODUCTS - ACCESSORIES - GLOVES

ACCESSORIES

The **GLOBE BACKING PADS FOR FIBERDISCS** are built with a mix of plastic materials and with such a geometry to give the right flexibility to work properly and maximising the performance of the abrasive fiberdisc. Flexibility remains constant also with temperature changes.

DIMENSIONS (diam.) mm	DESCRIPTION	ARTICLE CODE	
115	BACKING PAD FOR FIBERDISC	G3400 115	1pc
125	BACKING PAD FOR FIBERDISC	G3400 125	1pc



GLOBE STEEL SPACERS, available in 3 different heights, adapt to all machines available on the market. Shaped like the plastic spacers but higher can be used for all types of abrasive wheels. By choosing the correct height, it is possible to position the abrasive disc in a convenient way (be careful that the disc is always included inside the safety guard of the grinding machine). Useful for grinding discs and depressed center cutting discs to take the working part of the wheel in the most comfortable and convenient position for a precise and effective work.

DIMENSIONS (thick) mm	DESCRIPTION	ARTICLE CODE	
12	SPACER FOR TURBOTWISTER	G0800-12	1pc
16	SPACER FOR TURBOTWISTER	G0800-16	1pc
18	SPACER FOR TURBOTWISTER	G0800-18	1pc



VIBLOCK (all details on pag. 45)

	DESCRIPTION	ARTICLE CODE	
NEW	SET OF STEEL DAMPING FLANGES (BORE M14)	G3330 VIB LOCK	1pc
NEW	SET OF STEEL DAMPING FLANGES (BORE 5/8-11W)	G3330 VIB LOCK 5/8	1pc



The new **STEEL FLANGES** were conceived to be used with semi-flexible discs and depressed center cutting discs. They allow to perfectly mount the disc and to position it in the most convenient way for working. The telescopic clamping flange guarantees a perfect balance without vibrations.

DESCRIPTION	ARTICLE CODE	
SET OF STEEL FLANGES FOR FLEXCELLENCE (BORE M14)	G3330	1pc
SET OF STEEL FLANGES FOR FLEXCELLENCE (BORE 5/8-11)	G3330 5/8	1pc

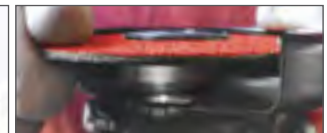

The **PLASTIC SPACER** are a practical and economical solutions for the use of some products which, in order to work to the best, need to be positioned more near the edge of the safety guard (depressed center cutting discs, FLEXCELLENCE semi-flexible discs and TURBOTWISTER). They are supplied free of charge in every packaging of the above mentioned products but, if necessary, they are also supplied separately.

DESCRIPTION	ARTICLE CODE	
PLASTIC SPACER FOR FLEXCELLENCE (BORE M14)	G3330 SPAC. M14	5pcs
PLASTIC SPACER FOR FLEXCELLENCE (BORE 5/8-11)	G3330 SPAC. 5/8	5pcs





ADAPTOR RINGS FOR BIG DIAMETER CUTTING DISCS plastic adaptor rings to adapt (when necessary) the disc bore to the relevant pivot (shaft) of the machine.

REDUC. CUTTERS (Ø external/Ø internal)	ARTICLE CODE	REDUC. CUTTERS (Ø external/Ø internal)	ARTICLE CODE	REDUC. CUTTERS (Ø external/Ø internal)	ARTICLE CODE
20,00/16,00	RIDUZ20/16 •	29,00/22,23	RIDUZ29/22 •	40,00/32,00	RIDUZ40/32 •
22,23/12,00	RIDUZ22/12 •	30,00/16,00	RIDUZ30/16 •	40,00/35,00	RIDUZ40/35 •
22,23/16,00	RIDUZ22/16 •	30,00/20,00	RIDUZ30/20 •	50,80/22,23	RIDUZ50/22 •
22,23/20,00	RIDUZ22/20 •	30,00/22,23	RIDUZ30/22 •	50,80/25,40	RIDUZ50/25 •
25,40/12,70	RIDUZ25.4/12.7 •	30,00/25,40	RIDUZ30/25 •	50,80/30,00	RIDUZ50/30 •
25,40/16,00	RIDUZ25.4/16 •	35,00/28,00	RIDUZ35/28 •	50,80/32,00	RIDUZ50/32 •
25,40/19,00	RIDUZ25/19 •	40,00/22,23	RIDUZ40/22 •	50,80/35,00	RIDUZ50/35 •
25,40/20,00	RIDUZ25/20 •	40,00/25,40	RIDUZ40/25 •	50,80/40,00	RIDUZ50/40 •
25,40/22,23	RIDUZ25/22 •	40,00/30,00	RIDUZ40/30 •		



REDUCTION PIVOTS FOR STRAIGHT GRINDERS

DESCRIPTION (unit of measurement) mm	ARTICLE CODE		DESCRIPTION (unit of measurement) mm	ARTICLE CODE	
SHAFT 6,35-THREAD 8,00	PERN01 •	1pc	SHAFT 6,00-THREAD 8,00	PERN04 •	1pc
SHAFT 6,35-THREAD 9,53	PERN02 •	1pc	SHAFT 6,00-THREAD 9,53	PERN05 •	1pc
SHAFT 8,00-THREAD 9,53	PERN03 •	1pc	SHAFT 6,00-THREAD 6,35	PERN06 •	1pc



PROFESSIONAL GLOVES AND WELDING APRONS

NEW
NEW
NEW
NEW
NEW
NEW

TYPE OF PRODUCT AND USE	SIZE	ARTICLE CODE	PACKAGING	
MULTI-PURPOSE GLOVES	TG.06	G4911 06 •	PAIRS	12pcs
MULTI-PURPOSE GLOVES	TG.07	G4911 07 •	PAIRS	12pcs
MULTI-PURPOSE GLOVES	TG.08	G4911 08 •	PAIRS	12pcs
MULTI-PURPOSE GLOVES	TG.09	G4911 09 •	PAIRS	12pcs
MULTI-PURPOSE GLOVES	TG.10	G4911 10 •	PAIRS	12pcs
MULTI-PURPOSE GLOVES	TG.11	G4911 11 •	PAIRS	12pcs



Nitrile, multipurpose gloves with remarkable perforation resistance. Despite their strength, they offer an excellent level of tactile sensitivity. Aerated back. EN 388.

TYPE OF PRODUCT AND USE	SIZE	ARTICLE CODE	PACKAGING	
ANTI-SLIP BLACK GLOVES	TG.08	G4901 08 •	PAIRS	12pcs
ANTI-SLIP BLACK GLOVES	TG.09	G4901 09 •	PAIRS	12pcs
ANTI-SLIP BLACK GLOVES	TG.10	G4901 10 •	PAIRS	12pcs
ANTI-SLIP BLACK GLOVES	TG.11	G4901 11 •	PAIRS	12pcs



Nylon gloves: seamless, covered by nitril rubber, perfect grip also on oily surfaces, excellent resistance to abrasion, aerated back. EN 388.

TYPE OF PRODUCT AND USE	SIZE	ARTICLE CODE	PACKAGING	
CUT RESISTANT GLOVES (GREY)	TG.06	G4902 06 •	PAIRS	12pcs
CUT RESISTANT GLOVES (GREY)	TG.07	G4902 07 •	PAIRS	12pcs
CUT RESISTANT GLOVES (GREY)	TG.08	G4902 08 •	PAIRS	12pcs
CUT RESISTANT GLOVES (GREY)	TG.09	G4902 09 •	PAIRS	12pcs
CUT RESISTANT GLOVES (GREY)	TG.10	G4902 10 •	PAIRS	12pcs
CUT RESISTANT GLOVES (GREY)	TG.11	G4902 11 •	PAIRS	12pcs



High-performance polyethilen (HPPE) gloves covered by grey polyurethane, excellent cut resistance, aerated back. EN 388 level 5.

TYPE OF PRODUCT AND USE	SIZE	ARTICLE CODE	PACKAGING	
WHITE FULL GRAIN LEATHER GLOVE	TG.08	G4903 08 •	PAIRS	12pcs
WHITE FULL GRAIN LEATHER GLOVE	TG.09	G4903 09 •	PAIRS	12pcs
WHITE FULL GRAIN LEATHER GLOVE	TG.10	G4903 10 •	PAIRS	12pcs
WHITE FULL GRAIN LEATHER GLOVE	TG.11	G4903 11 •	PAIRS	12pcs



Soft bovine glove, full grain leather, high quality. EN 388 - EN 420.

TYPE OF PRODUCT AND USE	SIZE	ARTICLE CODE	PACKAGING	
MIG WELDER GLOVE	TG.09	G4904 09 •	PAIRS	10pcs
MIG WELDER GLOVE	TG.10	G4904 10 •	PAIRS	10pcs
MIG WELDER GLOVE	TG.11	G4904 11 •	PAIRS	10pcs



Bovine crust leather gloves especially padded and reinforced to protect operators during welding. Kevlar stitching. EN 12477.

TYPE OF PRODUCT AND USE	SIZE	ARTICLE CODE	PACKAGING	
TIG WELDER GLOVE	TG.09	G4905 09 •	PAIRS	12pcs
TIG WELDER GLOVE	TG.10	G4905 10 •	PAIRS	12pcs
TIG WELDER GLOVE	TG.11	G4905 11 •	PAIRS	12pcs

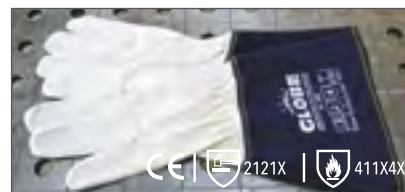

Soft kid leather glove for protection during TIG welding operations while allowing hands to maintain maximum sensitivity. EN 12477.



CAT. I

EN ISO 13851



Classe 2



TYPE OF PRODUCT AND USE	SIZE	ARTICLE CODE	
WELDER APRON	ONE SIZE	G4900 •	1 pc
WELDER APRON TOP	ONE SIZE	G4900 TOP •	1 pc

NEW
NEW

RIGHT: high-resistance apron in soft cowhide crust with practical snap opening and closing system with adjustable strap at both the neck and waist and riveted front pocket for objects. Kevlar seams and perimeter finishing.

Size: 70x90 cm (bxh) - Thickness: 1,6 - 1,8 mm.
CERTIF. Cat. I, Class 2 (A1), EN-11611.

DESTRA: grembiule ad alta resistenza in morbida crosta bovina con pratico sistema di apertura e chiusura a scatto con fettuccia regolabile sia al collo che in vita e tasca frontale porta oggetti rivettata. Cuciture e rifinitura perimetrale in Kevlar.

Size: 60x91 cm (bxh) - Thickness: 2,0 - 2,2 mm.
CERTIF. Cat. I, Class 2 (A1), EN-11611.

• = articles always in stock

PACKAGING AND DISPLAYS



GLOBE PACKAGING

FATENTED

GLOBE is proud to present the exclusive line of cylindrical boxes. This original solution, conceived and patented by GLOBE, gives an immediate perception of the quality as well as a modern and professional look. The protection offered by these solid and resistant boxes is higher than traditional cardboard boxes.

Caps are always sealed with an easily removable tape. Boxes with the same diameter can be stacked by making goods' storage easier and tidy. Materials used are 100% recyclable, but these boxes often find a second life in workshops to contain various objects, making a "plus" of the GLOBE product.

The interlocking stackable cap and bottom of GLOBE boxes allow a better preservation of the product and a perfect and stable stackability.

FLOOR AND COUNTER DISPLAYS

In support of its production, GLOBE makes available some counter and floor displays for its customers. The floor display is conceived by a famous designer of Milan, and it is made by a solid steel thin sheet, with special attention to detail and equipped with a comfortable ground drawer. It immediately draws attention with a pleasant and modern look presenting GLOBE production at best. The back multi hole panel allows to position the supports on the desired configuration adapting to contain and support all types of wheels and other GLOBE products. Counters displays, available both in the steady and rotating version. Comfortable and practical to show discs and let them be touched by customers.

DIMENSIONS (bx dx h) cm	DESCRIPTION	ART. CODE	
18x30x52	ROTATING COUNTER DISPLAY*	ESPBANCOGIREVOLE	1pc
45x24x36	INOX COUNTER DISPLAY	ESPBANCO •	1pc
65x42x192	FLOOR DISPLAY*	ESPOSITORE •	1pc

* = ganci porta prodotto inclusi



Stainless steel counter display.
Dimensions: 45x24 cm
with 6 slots for discs from 115 to 125 mm.



Rotating counter display: perforated sheet metal like the floor display. Can hold 12 discs' types (6 each side) of 115/125 mm. Practical, very capacious and not bulky: 18x30 cm.



Thin sheet floor display.
65x42x192 cm composed by:
1 perforated wall, 3 shelves
2 side edges, 1 base with drawer.

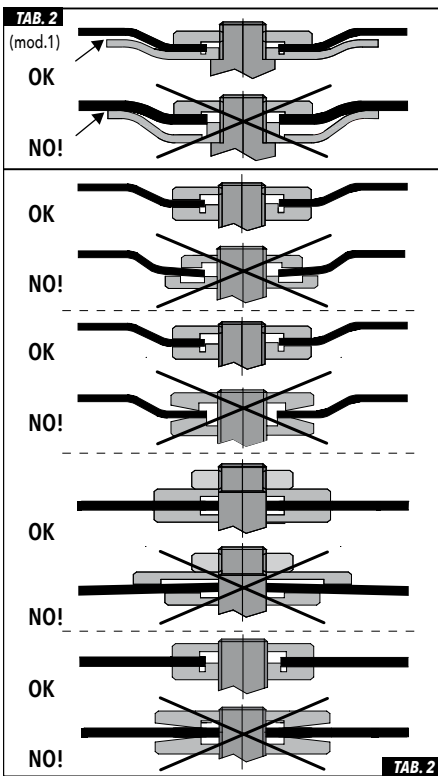

OPERATING AND SAFETY INSTRUCTIONS FOR THE USE OF RESIN-BONDED, RIGID, SEMI-FLEXIBLE AND FLEXIBLE ABRASIVE PRODUCTS.

READ CAREFULLY AND SHARE WITH ALL OPERATORS.

For further information on: selection, features, use and safety of abrasive products, please refer to the general catalogue, our website www.globeabrasives.com or contact us. Abrasive wheels can generate dangerous situations and/or create accidents. Read carefully the following information and the labels' indications: operators must be instructed to use abrasive product; operators must comply with the laws and decrees of their country and the safety/operating instructions of the machines on which abrasive wheels are mounted. Do not allow untrained/incompetent operators to use abrasive wheels. Abrasive wheels are relatively fragile: handle and use with care. The use of damaged wheels, the non correct use and the non correct installation can cause accidents, damages and serious injuries to persons. Cutting, grinding and polishing applications can free hazardous contaminants in the air. Use appropriate powder/fumes suction systems and wear protection devices for respiratory tract.

RECALLS ON PRODUCTION BATCHES.

Before using an abrasive product, check the page "recalled batch" on our website and, following the instructions, verify if the product is part of a recalled batch. Should this be the case, do not use the product, isolate it and all the other wheels coming from the same box/batch and contact our customer service.

EXPIRY.

Lifetime of resin-bonded abrasive wheels is **3 years** from production date **if reinforced (BF on label)** or **2 years if without reinforcement (B on the label)**. The expiry date can be shown on the boxes, on the central metal hub, through cuts on the label perimeter or printed on one of the 2 sides of the disc. **Never use expired wheels.** These wheels are manufactured according the following norms: **EN12413 (EU), ANSI B7.1 (USA), AS 1788.1 (AUS).**

CHECKING, TRANSPORT, HANDLING AND STORAGE.

Verify packaging damages; refuse damaged packagings; handle with care and avoid shocks; store at temperatures between 10°C (50°F) and 30°C (86°F) and humidity around 45%; do not expose wheels to frost and high humidity conditions, water or chemical products such as solvents. Always use oldest wheels, but make sure they are not expired. For a correct choice, contact us, refer to our catalogue or our web site.

WHEEL INSPECTION.

Before mounting the wheel, make sure it is not cracked or damaged. Do not use wheels if damaged (fig.7) or expired. Carry out a sound check by striking one side of the disc with a non metallic object (screwdriver handle). If the sound is damp and not clear, reject the wheel. Do not use wheels that were exposed to too high/too low temperatures/humidity or that have been artificially or accidentally wet.

MACHINE INSPECTION.

Check flanges, backing pads, support pivots and adapters. Make sure the grinder is suitable for the type of work to be made and that the wheel is adequate for the grinder. Always use with suitable safety guard (fig.6). Always direct the open part of the safety guard to a direction opposite to the operator. Keep machines in an efficient state. Do not use machines that do not indicate the rotation speed on the nameplate or that do not have it.

EYES, FACE AND BODY PROTECTION.

Use eye and face protections as masks, screens and glasses (fig.2). Wear hats or head protection, heavy leather apron, safety shoes, tight fitting clothes. The noise generated by the wheels can exceed 80 dBA. A prolonged exposure can cause permanent damages to hearing. Use ear protection such as earplugs and anti-noise screens (fig.3). The vibrations generated by the wheels can cause damages to the human body. Adopt work turnover and resting breaks. Carry out a specific evaluation of the noise and vibrations risk and adopt suitable protection and precautions. Wear protective gloves that fully cover also wrists (fig.4). Carry out an evaluation of the physical, chemical risks associated with the use of abrasive products and adopt suitable precautions and protective measures. Protect the respiratory tract: use masks with special filters, air respirator systems, protective measures of the working environment such as ventilation systems, filtration and powder/fume suction (fig.5). Nearby personnel must be protected with all the above precautions/measure.

ASSEMBLY INSTRUCTIONS.

Follow the assembly instructions supplied with the machine and the use restrictions shown on the wheel label (fig.1). Make sure the maximum turning speed (RPM) of the machine is always, in any operating condition, lower than or equal to the speed shown on the wheel label. A transversal coloured stripe on the wheel label indicates also its operating peripheral speed according to the following scheme: **TAB.1:**

None	lower than 50 m/s	Blue	up to 50 m/s	Yellow	up to 63 m/s
Red	up to 80 m/s	Green	up to 100 m/s		

Check that dimensions and shape of the wheel correspond to those allowed for the machine. Check that the wheel is wholly contained within the safety guard of the grinder. Do not modify the clamping flanges. Before mounting or dismounting an abrasive wheel, disconnect the power supply (electric energy, compressed air, etc.). Do not force wheels during assembly. Avoid clamping with too high tightening torque. Once the wheel is installed, make sure that it rotates freely by turning it by hand. Check the presence, correct installation and securing of the safety guard. Connect the power supply, start the machine and make it turn for at least 30". During this test, do not keep the open area of the safety guard oriented towards the operator and other personnel. In case anomalies, vibrations, irregular rotation should occur, let the grinder stop naturally, disconnect power supply, remove the wheel and check its assembly. If the problem persists, reject the wheel and inform the supplier of the problem. Some types of wheels can be supplied with mounting blotters that have to be mounted between the flanges and each side of the disc to compensate slight irregularities of surfaces between flanges and wheels.

CLAMPING FLANGES.

Make sure the flanges are flat, clean and smooth. Always use suitable flanges. **TAB.2** Flanges must have the same diameter and the same shape (recesses) towards both faces of the wheel; make exception the raised hub flanges (mod. 1 of TAB.2).

Flanges diameter: for cutting and grinding wheels is normally equal to 1/3 of the wheel diameter.

Make exception: reinforced depressed centre grinding wheels (Type 27), reinforced conical (Type 28), semi-flexible reinforced (Type 29), reinforced depressed centre cutting wheels (Type 42) and flat (Type 41) up to diameter 230mm, that must have the following flanges diameters:
 -19mm (wheel diameter ≤ 100mm and bore ≤ 10mm)
 -32mm (wheel diameter ≤ 100mm and bore between 10 and 16mm)
 -41mm (wheel diameter between 100 and 230mm, bore 22.23mm).

INDICATIONS SHOWN ON WHEEL LABEL.

Specifications characterizing the wheel: wheel dimension; Type of abrasive (A, Z, C, SG); granulometry of the abrasive (16, ..., 100) expressed in Mesh. **Hardness:** scale of toughness shown with letters from A (very soft) to Z (very hard). Resin binder shown by "B" and reinforcement structure shown by "F" on label.

Maximum allowed turning speed (RPM) and maximum allowed peripheral speed (m/s): the most common peripheral speeds are 50-63-80-100m/s.

Reference norms: EN12413, ANSI B7.1.

Indications on the workable materials: steel, aluminium, cast iron, stainless steel, stone, marble, etc.

Shape types TAB.3: (Type 1) straight grinding wheel; (Type 27) depressed centre grinding wheel; (Type 28) conical grinding wheel; (Type 29) depressed centre semiflexible grinding wheel; (Type 41) flat cutting wheel; (Type 42) depressed centre cutting wheel.

Pictograms TAB.4: from fig.1 to fig.7 explained above; (fig.8) do not use for side grinding; (fig.9) do not use on portable machines (wheels made only for stationary machines); (fig.10) not suitable for wet grinding/cutting; (fig.11) only suitable for wet grinding/cutting; (fig.12) only for totally enclosed machines; (fig.13) only for grinding with angle greater than 10°.

USE INSTRUCTIONS AND RESTRICTIONS.

Use the wheels only and exclusively for uses, materials and type of machine for which they are intended; do not use cutting discs (Ex. Type 41 e 42) for grinding and not applying lateral loads on them; always keep the grinder with two hands; perform the sanding or cutting progressively, slowly and delicately; do not apply too heavy loads on the wheels; do not make curvilinear cuts; do not use the side of the disc for grinding unless expressly indicated (Ex. Type 1); do not cut or grind objects subject to forces or pressures that could be freed as a result of the cutting/deburring action. Remove all combustible, flammable or explosive materials from the work area; firmly fix the workpieces before starting work. Allow the product to cool down during use by making it spin freely for a while. If the product hangs in the processed material, stop the machine and try to pull it out without straining and/or levering it. Check the integrity and flatness of the product before using it again. If a disk breaks during use, stop processing, isolate the disk and the entire lot and notify the distributor or manufacturer.

Dispose of the products according to the National laws in force in your country.

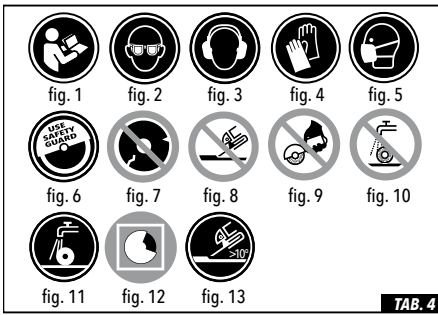
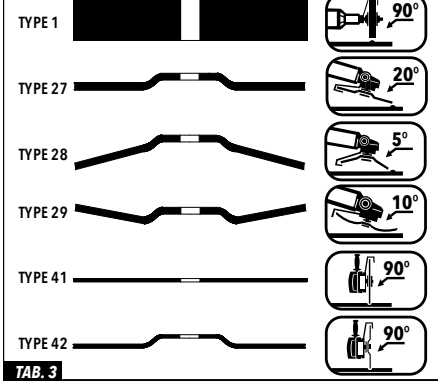

OPERATING AND SAFETY INSTRUCTIONS FOR THE USE OF COATED ABRASIVES (FLAP DISCS, FLAP WHEELS, SANDING DISCS, ABRASIVE SHEETS, ROLLS, BELTS, ETC.).

READ CAREFULLY AND SHARE WITH ALL OPERATORS.

For further information on: selection, features, use and safety of abrasive products, please refer to the general catalogue, our website www.globeabrasives.com or contact us. Coated abrasive products can generate dangerous situations and/or create accidents. Read carefully the following instructions and the indications on the labels. Operators must be instructed on the use of abrasive products, comply with the laws and decrees of their country and the safety operating instructions of the grinders on which abrasive products are mounted. Do not allow untrained/incompetent operators to use abrasive products. Coated abrasive products are relatively fragile: handle and use them with care. The use of damaged products, the inadequate mounting and use can cause accidents, damages and serious injuries to people. Grinding and polishing applications can free hazardous contaminants in the air; use appropriate powder/fumes suction systems and wear protection devices for respiratory tract.

RECALLS ON PRODUCTION BATCHES.

Before using an abrasive product, check the page "recalled batch" on our website and follow the instructions, verify if the product is part of a recalled batch. Should this be the case, do not use the product, isolate all boxes from the same batch and contact our customer service.

EXPIRY.

Coated abrasive products have no expiry but we suggest they are used within **3 years** from the production date.

CHECKING, TRANSPORT, HANDLING AND STORAGE.

Verify packaging for damages and refuse shipment if it's the case. Handle with care, avoid shocks, store at temperatures between 10°C (50°F) and 30°C (86°F) and humidity around 45%. Do not expose products to frost, water or chemical products such as solvents. Always use the oldest products first. For a correct choice, contact us, refer to our catalogue or our web site.

CHECKING THE PRODUCT.

Before mounting, make sure that the product is not cracked or damaged. Do not use damaged products (fig.7).

GRINDER INSPECTION.

Check flanges, backing pads, support pivots and adapters. Make sure the grinder and the product to mount are compatible and suitable for the type of work to be done. Always use with the safety guard supplied with the grinder (fig.6). Always direct the open part of the safety guard to a direction opposite to the operator. Keep machines in an efficient state. Do not use machines that do not indicate the rotation speed on the nameplate or that do not have it.

EYES, FACE AND BODY PROTECTION.

Use eye and face protection such as mask, screen and glasses (fig.2), hat or head protection, heavy leather apron, safety shoes and tight fitting clothes. The noise generated by coated abrasive products can exceed 80 dBA so a prolonged exposure can cause permanent damages to hearing. Use ear protection such as earplugs and anti-noise screen (fig.3). The vibrations generated by coated abrasive products can cause damages to the human body so make sure you adopt work turnovers and resting breaks. Carry out a specific evaluation of the noise and vibration risk and adopt suitable protections and precautions. Wear protective gloves that fully cover wrists (fig.4). Carry out an evaluation of the physical and chemical risks associated with the use of abrasive products and adopt suitable precautions and protective measures. Protect the respiratory

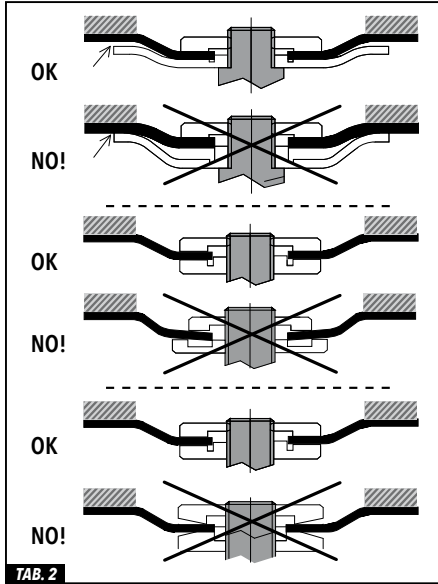

tract by wearing a mask with specific filters or air respirator systems. Use protective measures of the working environment such as ventilation, filtration and powder/fume suction systems (fig.5). Nearby personnel must be protected with all the above precautions/measures.

ASSEMBLY INSTRUCTIONS.

Follow the assembly instructions supplied with the grinder and the use restrictions shown on the abrasive product label (fig.1). Make sure the maximum turning speed (RPM) of the grinder is always, (in any operating condition) lower than or equal to the speed shown on the abrasive product label. A transversal colored stripe on the label also indicates its operating peripheral speed according to the following scheme **TAB.1**:

Blue	up to 50 m/s	Yellow	up to 63 m/s	Red	up to 80 m/s
------	--------------	--------	--------------	-----	--------------

TAB.1

For abrasive belts, make sure the peripheral speed of the driving rolls of the grinder is lower than or equal to the maximum speed allowed for the type of belt. Make sure that the dimensions and shape of the abrasive product correspond to those allowed for the grinder. Check that the abrasive product is wholly contained within the safety guard of the grinder. Do not modify the clamping flanges. Before mounting or dismounting an abrasive product, disconnect the power supply (electric energy, compressed air, etc.). Do not force during assembly. Avoid clamping with too high tightening torque. Once the abrasive product is installed, make sure that it rotates freely by turning it by hand before starting the grinder. Check the presence, correct installation and securing of the safety guard. Connect the power supply, start the grinder and make it turn for at least 30" before putting it in contact with the working piece.

During this test, do not keep the open area of the safety guard oriented towards the operator and other surrounding personnel. In case anomalies, vibrations, irregular rotation should occur, let the grinder stop naturally, disconnect power supply, remove the abrasive product and check its assembly. If the problem persists, reject the abrasive product and inform the supplier of the problem.

CLAMPING FLANGES.

Make sure the flanges are flat, clean and smooth. Always use suitable flanges **TAB.2**.

INSTRUCTIONS ON PRODUCTS' LABELS.

Specifications characterizing the product: dimensions; type of abrasive (A, Z, C, SG); granulometry of abrasive grit (16, ..., 100) expressed in Mesh.

Maximum allowed turning speed (RPM) and maximum allowed peripheral speed (m/s): the most common peripheral speeds are 50-63-80 m/s.

Reference norm: EN13743

Indications on the workable materials: steel, aluminium, cast iron, stainless steel, stone, marble, etc.

Pictograms TAB.3: from fig.1 to fig.7 explained above; (fig.8) only permitted with backup pad (for sanding discs); (fig.9) do not use on portable grinders; (fig.10) not suitable for wet grinding/polishing; (fig.11) only suitable for wet grinding/polishing.

USE INSTRUCTIONS AND RESTRICTIONS.

Use the coated abrasive products only and exclusively on materials, purposes and grinder types they have been designed for. Grind/polish progressively, slowly and delicately. Do not apply too much pressure and do not grind pieces subject to forces or pressures that could be released due to this operation. Remove all combustible, flammable or explosive materials from the working area. Firmly fix the work pieces before starting to work. Allow the product to cool down during use by making it spin freely for a while.

Flap discs: Use only with safety guard and at a 10° working angle (**TAB.4A**).

Abrasive belts: use only with safety guard. Do not touch the belt while moving. Store the belts hanged to drums of 50mm of minimum diameter. Do not damage the belt with sharp-edged pieces.

Flap wheels: check that the rotation direction corresponds to the one shown on the product.

Spindle mounted abrasive products: fit the spindle into the mandrel minimizing the protruding part and verify the rotation direction (**TAB.4B**).

Fibre discs: use only with safety guard and suitable backing pad and clamping flange. The disc must protrude the backing pad by at least 2 mm; use at a 10° working angle. (**TAB.4C**).

Dispose of the products according to the National laws in-force in your country.

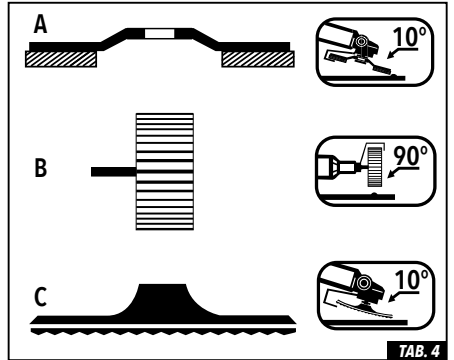
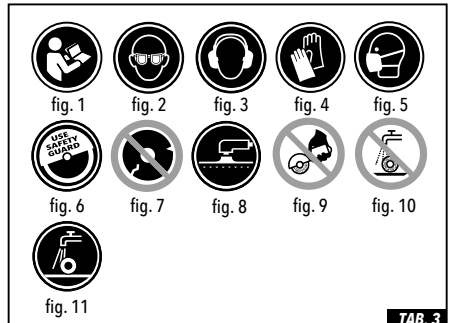

USE AND SAFETY INSTRUCTIONS FOR DIAMOND TOOLS.

READ CAREFULLY AND PROVIDE SAFETY INFORMATION TO THE OPERATIONAL STAFF.

These products are produced in compliance with the following norm: EN13236. Before handling or using the product, all the persons involved must know, understand, respect and apply carefully and thoroughly the above-mentioned regulations, the present document, the information written on the product itself or on the packaging, the manual of the machine used and the safety sheets of all materials involved (diamond tool, worked material, cutting lubricants, etc.); instruct your operators on the safe use of the product; make sure operators understand the instructions; do not allow untrained and/or incompetent persons handling and use abrasive products. Users must comply with the laws, decrees and regulations in force in their country and with the instructions for use and safety of the machines on which the products are installed. The following guidelines are not exhaustive: for more information and for safety sheets, please visit the SAFETY section, and/or contact us through the CONTACTS section on our website www.globeabrasives.com. Diamond tools must be handled and used with care. They may produce dangerous events and/or accidents and damages. The use of damaged, tampered, excessively worn products, outside their intended field of application or on unsuitable materials, improper use and incorrect installation may result in accidents, damages, and serious injuries to people. The use of the product may release contaminants into the air that are harmful to health. Check the safety data sheets for the materials involved in the work. Use appropriate collection systems of dust/fumes and wear respiratory protective devices.

RECALLED PRODUCTION BATCHES.

Before using an abrasive product, see the LIST OF RECALLED BATCHES section on our website and, following the instructions, check if the product belongs to a recalled production batch. If this happens, do not use the product, isolate the product and all those contained in the same packaging/production batch and contact our customer service through the CONTACTS section at www.globeabrasives.com.

EXPIRY.

Diamond tools do not expire.

CHECK, TRANSPORT, HANDLING AND STORAGE.

Check the presence of damages in the packaging; refuse deliveries with damaged packaging; handle with care and avoid impacts; do not expose the product to environments with humidity above 65%; do not expose to frost; for a correct product selection please refer to our catalog or our guide in the PRODUCTS section at www.globeabrasives.com.

PRODUCT CONTROL.

Before installing the product, check that the product itself is not cracked or damaged. Do not use damaged products (fig. 7).

MACHINE CONTROL.

Check flanges, shafts, adapters. Verify that the machine is suitable for the job to be carried out and the product is compatible with the machine. Always use only with the safety guard supplied together with the machine (fig. 6). Always orient the open part of the safety guard in the opposite direction to that of the operator and other people and make sure the safety guard itself is well adjusted and locked. Always keep the machines in good state of efficiency. Do not use machines that do not indicate the rotation speed on their plate or not provided with.

EYES, FACE AND BODY PROTECTION.

Wear eye and face protections such as masks, screens and glasses (fig.2). Wear hats or protections for the head, heavy leather aprons, safety shoes, tight-fitting clothing. The noise produced by abrasive products can exceed 80dBA. Prolonged exposure may cause permanent hearing damage. Use headphones, ear plugs, anti-noise screens (fig.3). Vibrations produced by diamond tools can cause damages to the human body; provide for frequent breaks and job rotation and use machines and/or gloves equipped with vibration reduction devices. Make a specific noise and vibration risk assessment by taking appropriate precautions and protections. Wear protective gloves that fully cover your wrists (fig.4). Evaluate the chemical and physical risks, associated with the use of the product and take appropriate preventive measures. Protect the respiratory tract, use masks, masks with specific filters or in the most extreme cases self-contained breathing apparatus; some building materials of quartz and asbestos nature may release dust and cause serious illnesses when working with diamond tools without the appropriate protective measures: use work environment protection systems such as ventilation, filtration and aspiration of dust (fig.5). Also the staff nearby should be adequately protected.

INSTALLATION INSTRUCTIONS.

Follow the instructions provided with the machine and the product as well as the operating restrictions indicated on its label (fig.1). Ensure that the maximum rotation speed per minute (RPM) of the machine is always (in any operating condition) less than or equal to that indicated on the product label. To further highlight the peripheral speed of use, the product may be marked by a transversal colored strip encoding the maximum permitted speed; Refer to www.globeabrasives.com (SAFETY section) to identify the speed corresponding to the colors of the strip. Check that sizes and shape of the product are compatible with the machine. Verify that the product is contained within the safety guard of the machine. Do not change the clamping flanges or the safety guard. Do not install more than one disc on the spindle. Before assembling or disassembling a diamond product, unplug the power source (electric current, compressed air, etc.). Do not force the assembly. Do not tighten with too high torques. Install the product, make sure it rotates freely by turning it by hand. Check the presence, correct installation and locking of the safety guards. Connect the power source, start the machine, and make it rotate loosely for at least 30s; during this test, keep the open area of the safety guard oriented in the opposite direction to the operator and never oriented towards other people. In case of anomalies, vibrations or irregular rotation, stop the machine, unplug the power supply, disassemble the product and check its assembly; if the problem persists, discard the product and inform the supplier about the problem. When turning off the machine, let the moving parts stop and unplug the power source; then proceed to disinstall the product. Do not try to stop the machine in different ways.

CLAMPING FLANGES (TAB.1) Make sure the flanges are flat, clean and smooth. Always use suitable flanges. The pairs of flanges must have the same diameter and the same shapes (recesses) to both sides of the grinding wheel; always use only the flanges supplied to the machines.

PRODUCTS MARKING.

Dimensions (outer diameter and hole diameter); maximum speed (RPM) and maximum peripheral speed (m/s) allowed; direction of rotation; reference standards: EN13236; instructions on the workable material; pictograms **TAB.2:** from fig.1 to fig.7 already illustrated above; (fig.8) do not use to grind; (fig.9) do not use on portable machines; (fig.10) do not use coolant; (fig.11) use only with coolant; (fig.12) wear safety shoes; (fig.13) wear a face shield (ISO 7010).

SPECIFIC INSTRUCTIONS FOR USE AND RESTRICTIONS.

Use the products only and exclusively for use, materials and type of machine for which they are intended; perform the work in a progressive, slow and gentle way; do not apply too much heavy loads; do not grind or cut objects subjected to forces or pressures that could be released as a result of cutting/grinding operations or in fire/explosion hazard areas. Remove all combustible, flammable or explosive materials from the work area; firmly fix the pieces to be worked before starting the operation; always hold portable machines with both hands. Do not use cutting discs to grind and do not apply side loads on them; do not perform curved cuts; to improve the abrading/cutting action of the diamond, it is recommended to perform a short "running-in" of the product on an abrasive material such as brick or disc-reviving brick in order to expose the diamond grains on the product surface. Every time the performances tend to decrease, repeat the "running-in" operation to revive the cutting edge. Allow the product to cool down during use by rotating it idle for a few moments. If the product is blocked in the worked material, stop the machine and try to pull it out without forcing and/or levering on it. Finally, check the integrity and planarity of the product before using it again.

Discard the used products according to the regulations in force.

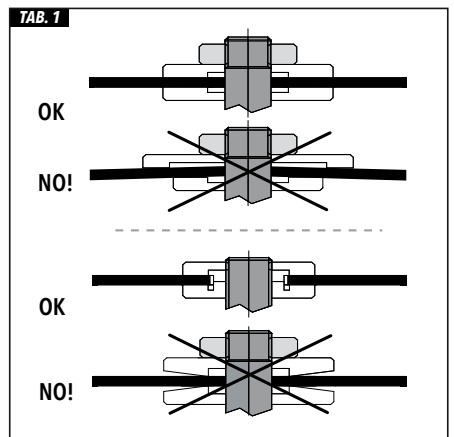

CONTACTS

INDUSTRIA ABRASIVI PARMENSE - GLOBE s.r.l.

PRODUCTION SITE AND ADMINISTRATIVE OFFICES

Via La Spezia, 160
43126 Parma - Italy
Tel: +39.0521.293943
Fax: +39.0521.293743

EXPORT SALES		export@globeabrasives.com
ITALY SALES		italy@globeabrasives.com
ADMINISTRATION		accounting@globeabrasives.com
INFO		info@globeabrasives.com

LOGISTIC SITE

Via Mistrali, 1/3
43046 Rubbiano di Solignano (PR) - Italy

WEB | www.globeabrasives.com



